

DWH Design Wall Panels

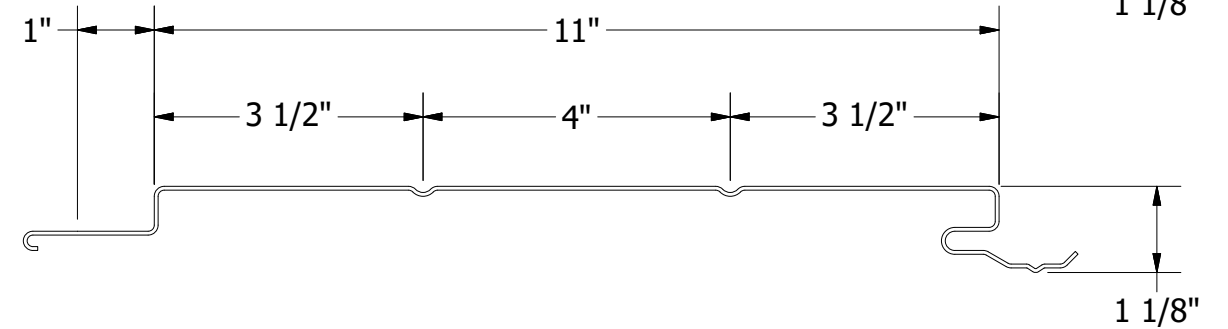
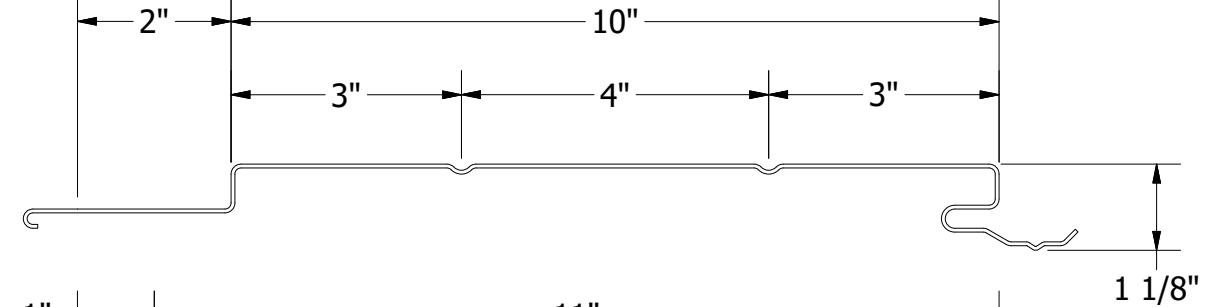
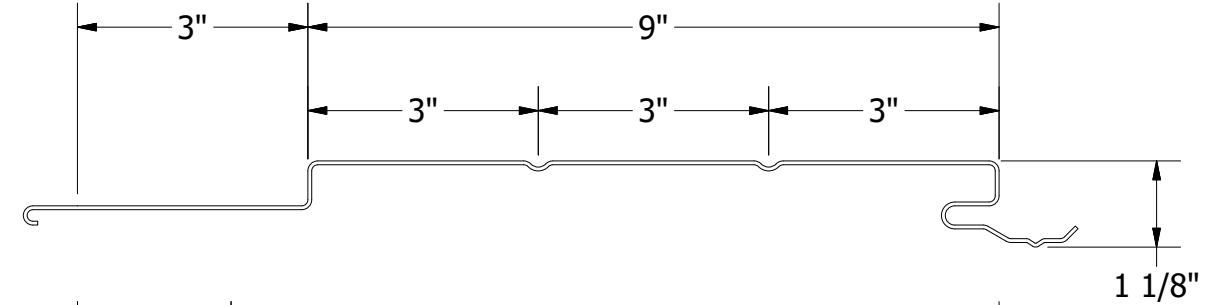
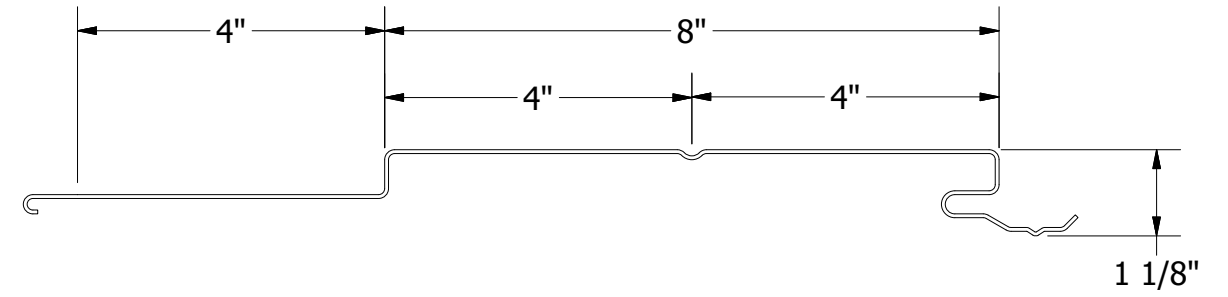
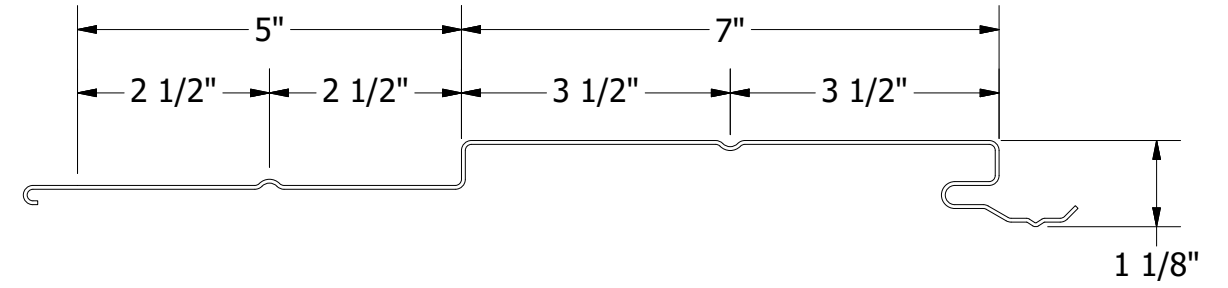
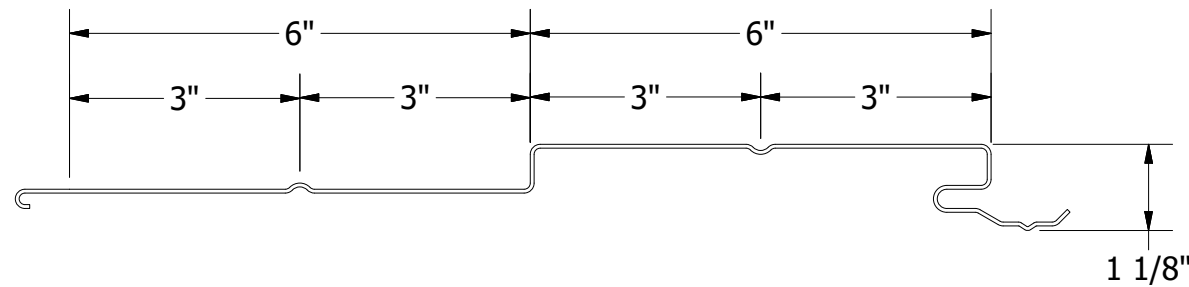
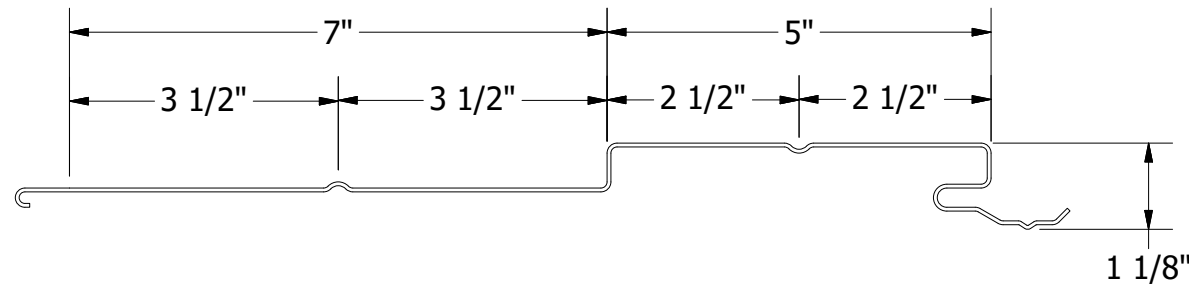
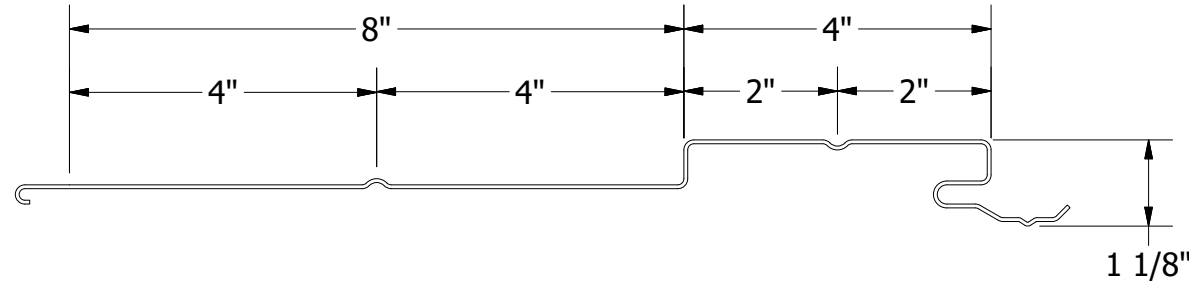
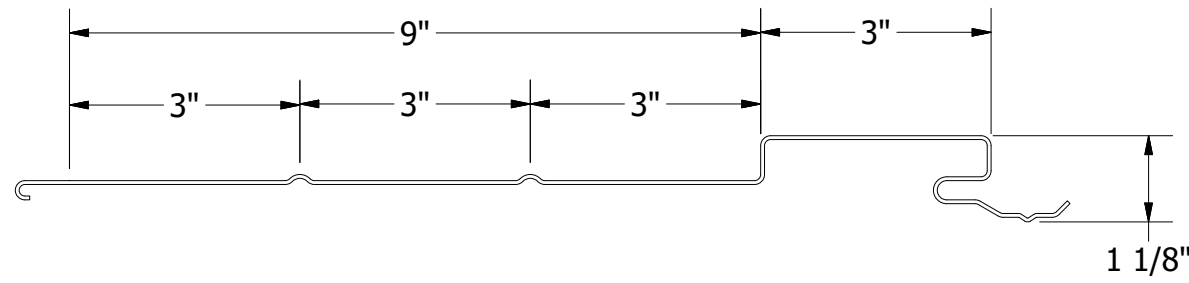
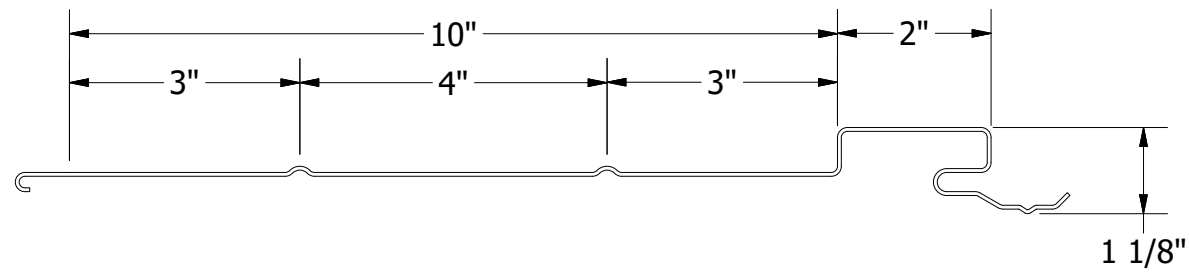

TITLE		DWH, DSH Soffit Panel Detail	
DWG. NO.	DR	KRK	DATE 6/6/2024
MATERIAL	APP		DATE
SH. SIZE	B	SCALE	X:X

REV. NO.	DATE	DESCRIPTION OF REVISION	BY	APP

DSH Design Wall Panels

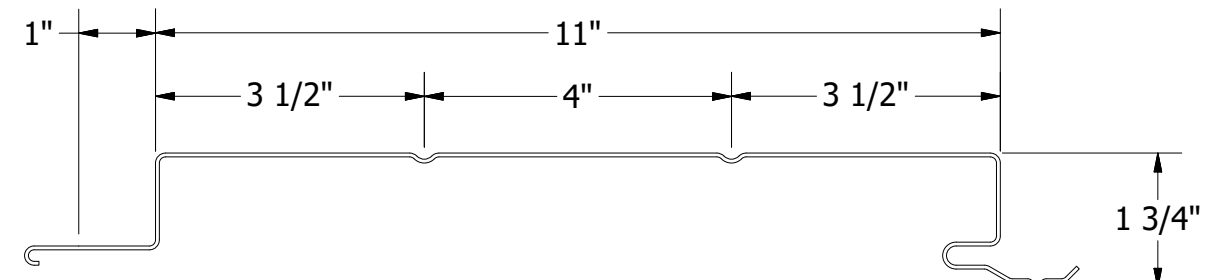
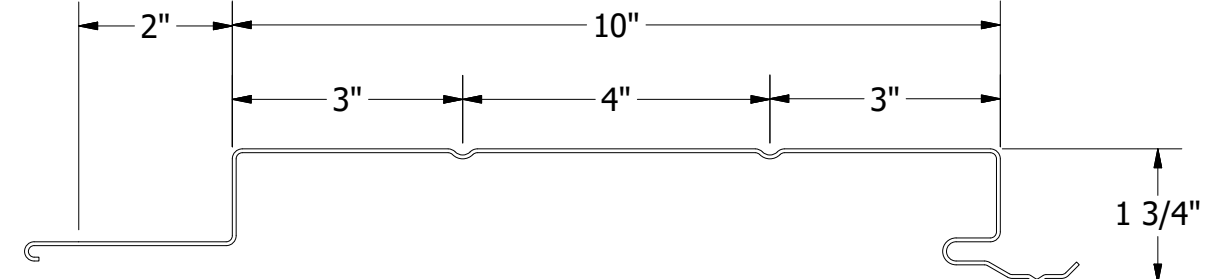
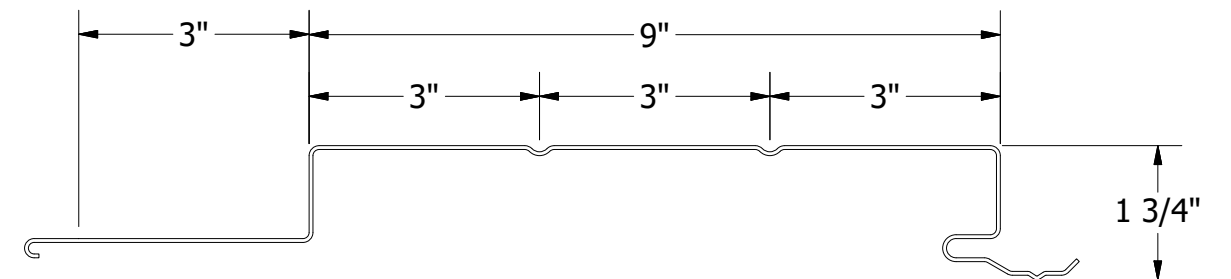
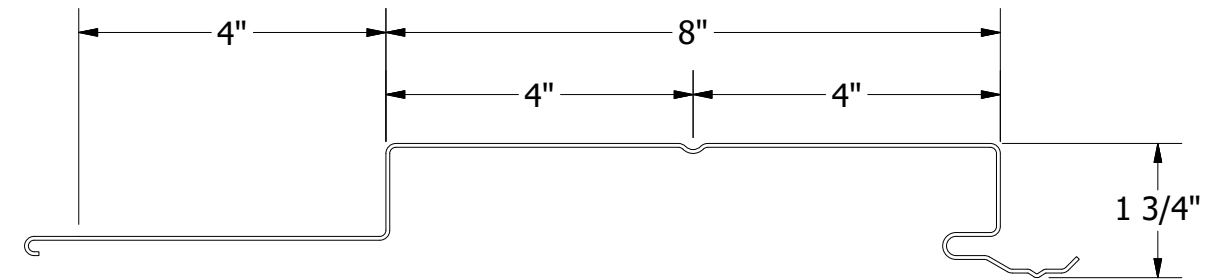
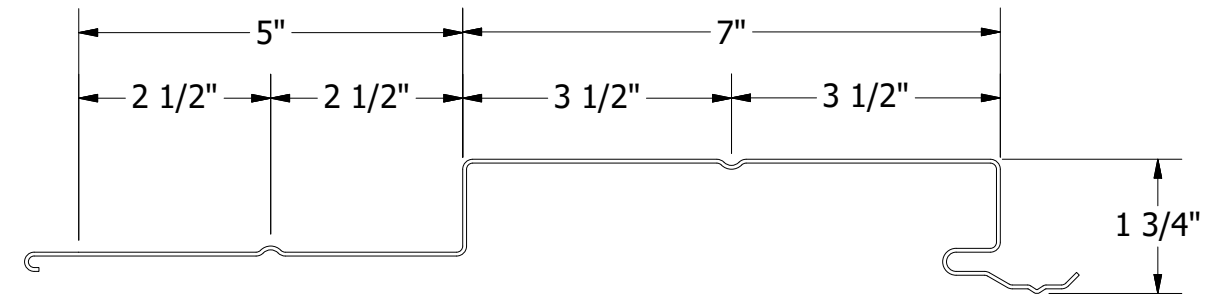
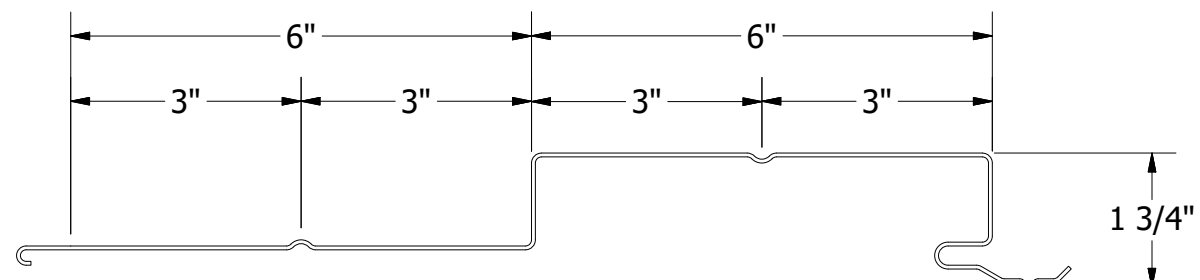
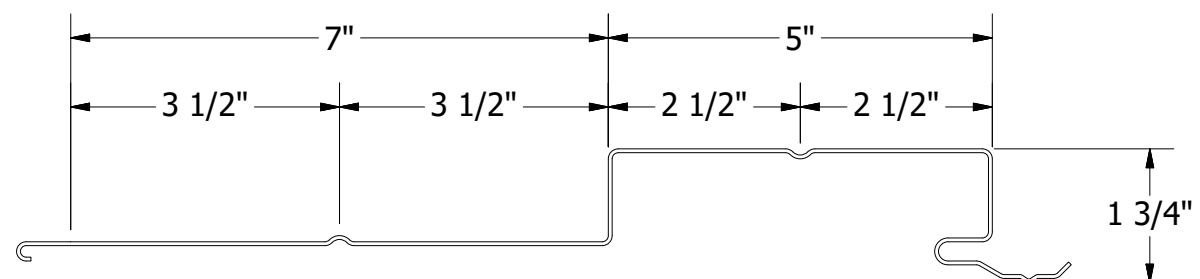
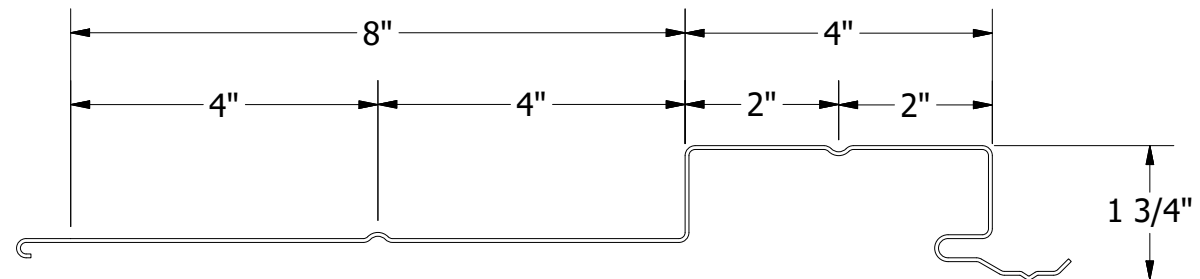
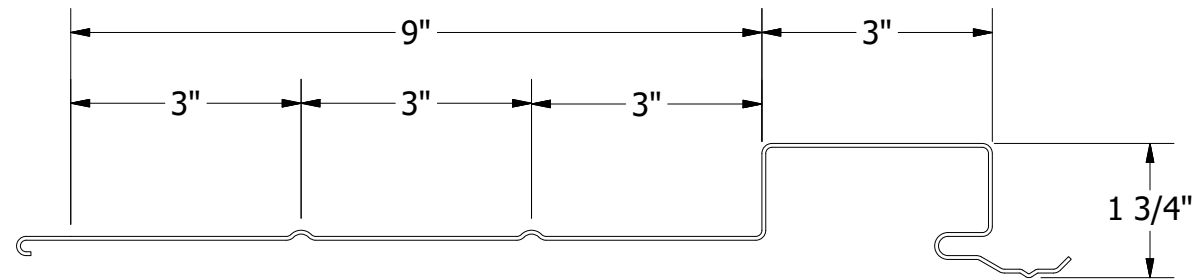
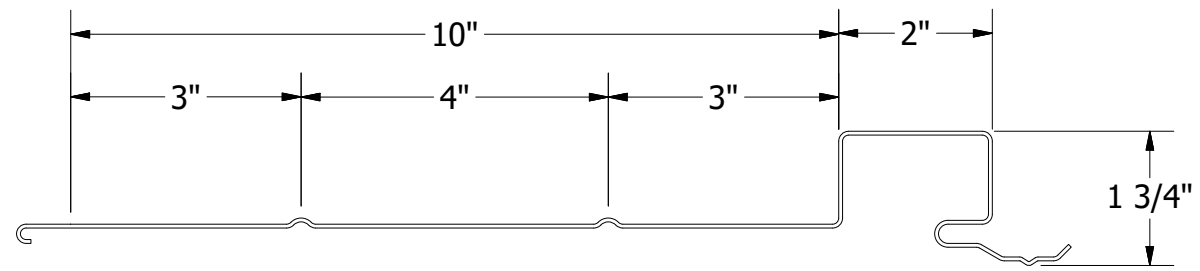

TITLE		DWH, DSH Soffit Panel Detail	
DWG. NO.	DR	DATE	6/6/2024
	KRK	APP	
MATERIAL	SH. SIZE	SCALE	X:X
	B		

REV. NO.	DATE	DESCRIPTION OF REVISION	BY	APP