

Pre-Drill Fastener Holes for Panels Greater than 20'-0" in Length

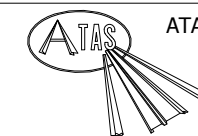

ATAS INTERNATIONAL, INC
 Allentown PA
 610-395-8445
 Mesa AZ
 480-558-7210

TITLE				Metafor Panel Detail	
DWG. NO.		DR		MBP	DATE 7/27/2016
REV. NO.		APP		DAS	DATE 7/27/16
DATE		DESCRIPTION OF REVISION		SH. SIZE	B SCALE X:X

Vertical Panel

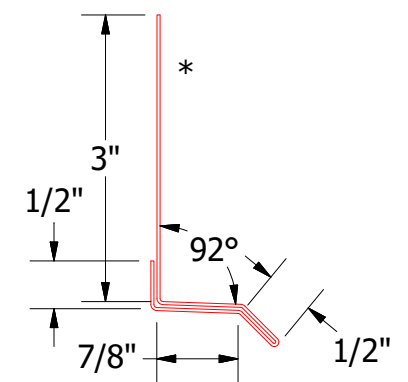
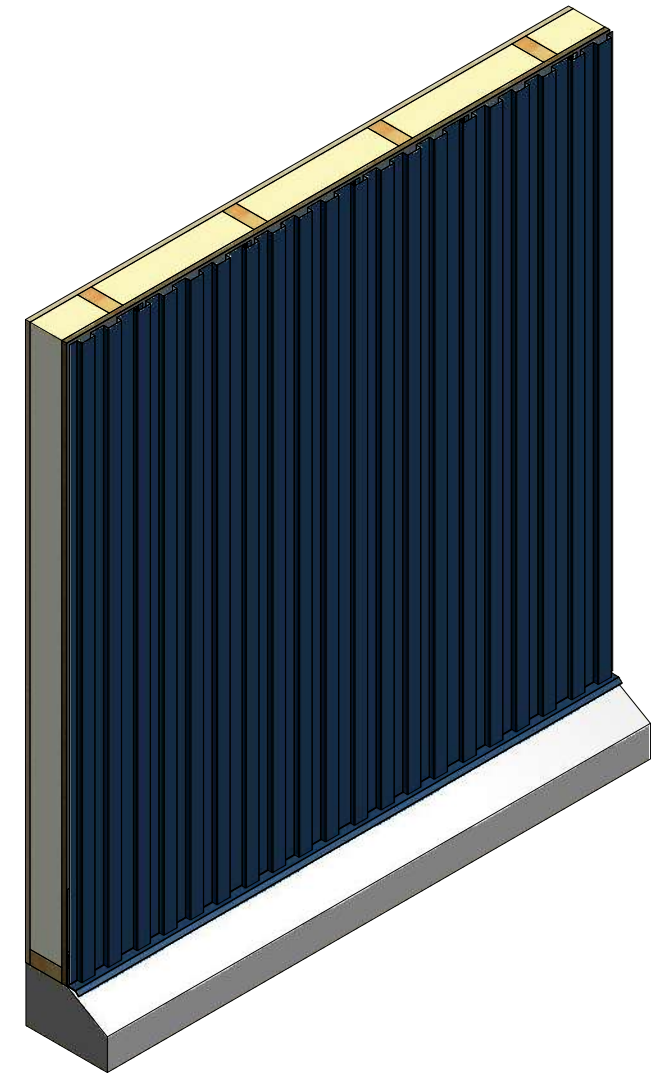
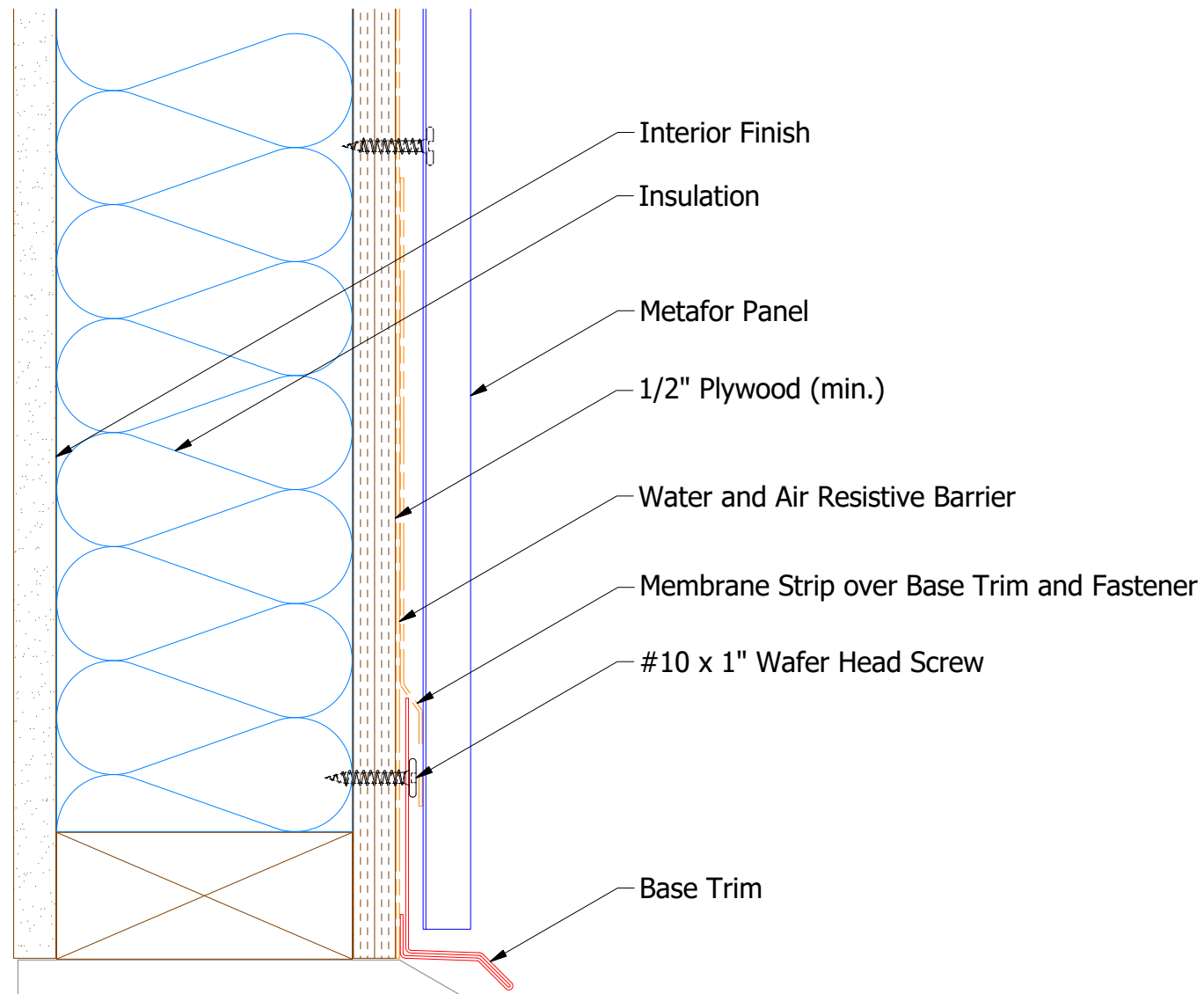

MFA661 - Base Trim

Note: * denotes color side.

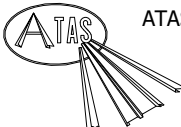
 ATAS INTERNATIONAL, INC Allentown PA 610-395-8445 Mesa AZ 480-558-7210	
TITLE Metafor Base Detail	
DWG. NO.	DR MBP DATE 7/7/2016
MATERIAL	APP DAS DATE 7/27/16
SH. SIZE	B SCALE X:X

REV. NO.	DATE	DESCRIPTION OF REVISION	BY	APP

Vertical Panel

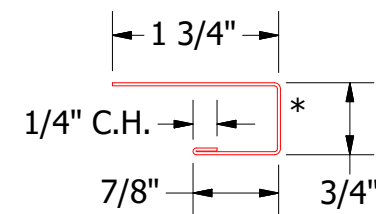
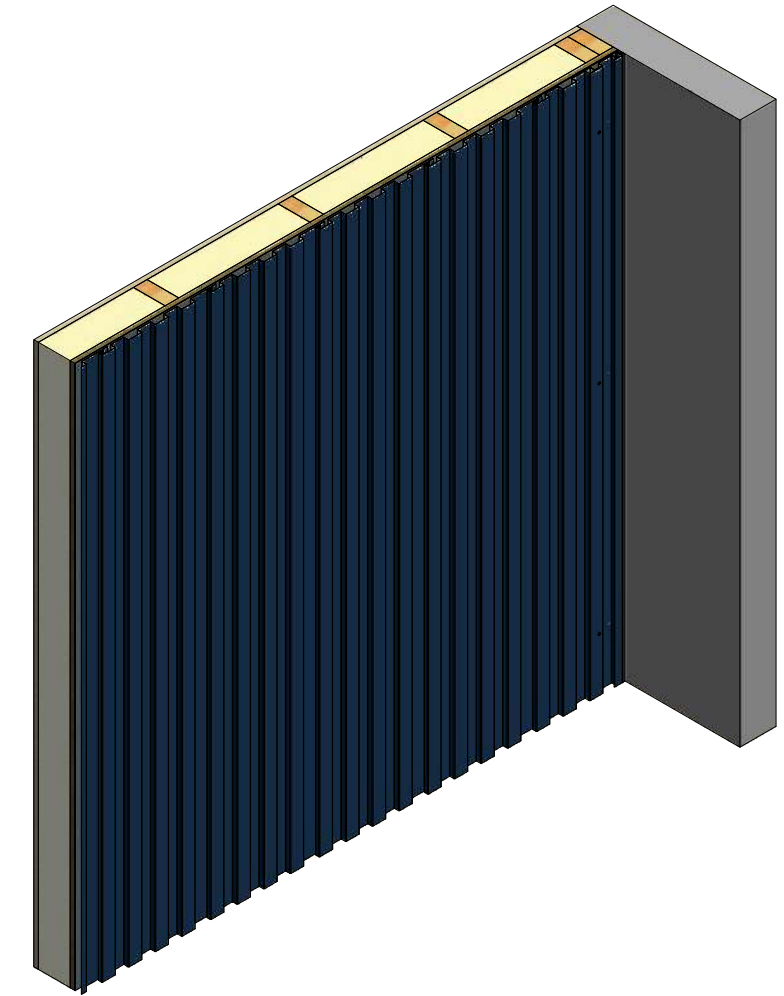
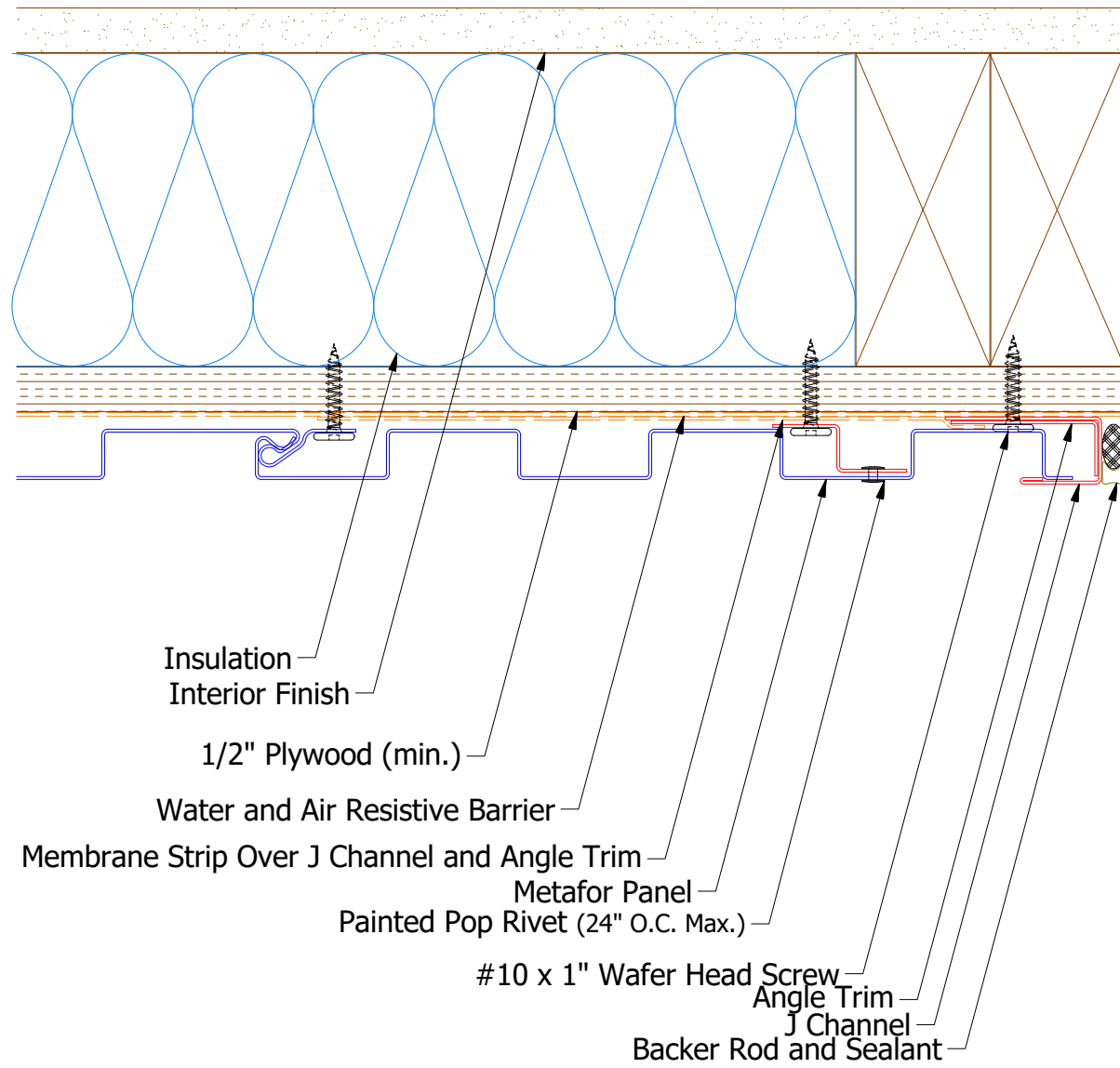

MFA034 - J Channel

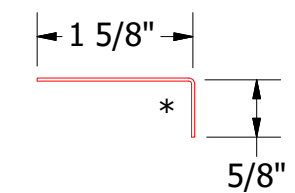

MFA680 - Angle Trim

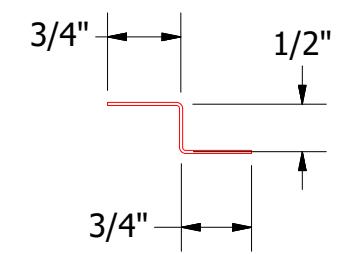

MFA681 - Support Z

Note: * denotes color side.

REV. NO.		DATE	DESCRIPTION OF REVISION	BY	APP	 ATAS INTERNATIONAL, INC Allentown PA 610-395-8445 Mesa AZ 480-558-7210	
TITLE						Metafor Endwall Detail	
DWG. NO.				DR	MBP	DATE	7/7/2016
MATERIAL				APP	DAS	DATE	7/27/16
				SH. SIZE	B	SCALE	X:X

Vertical Panel

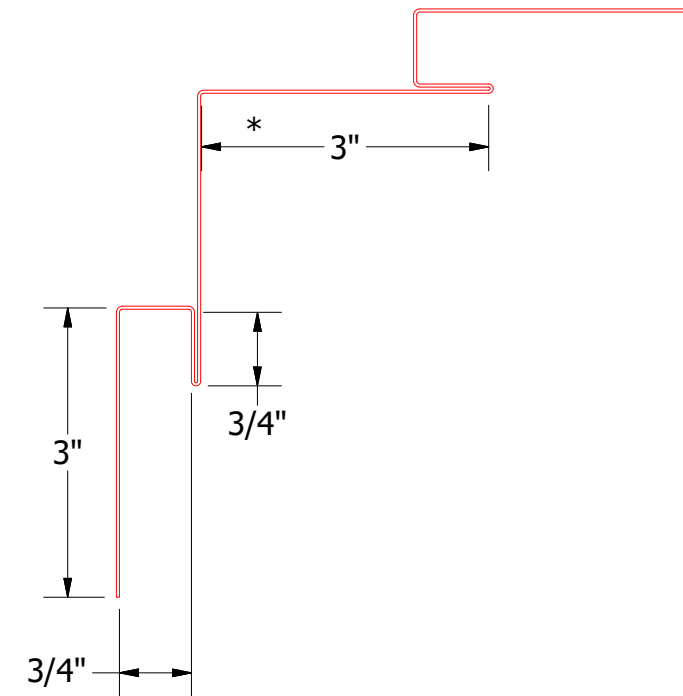
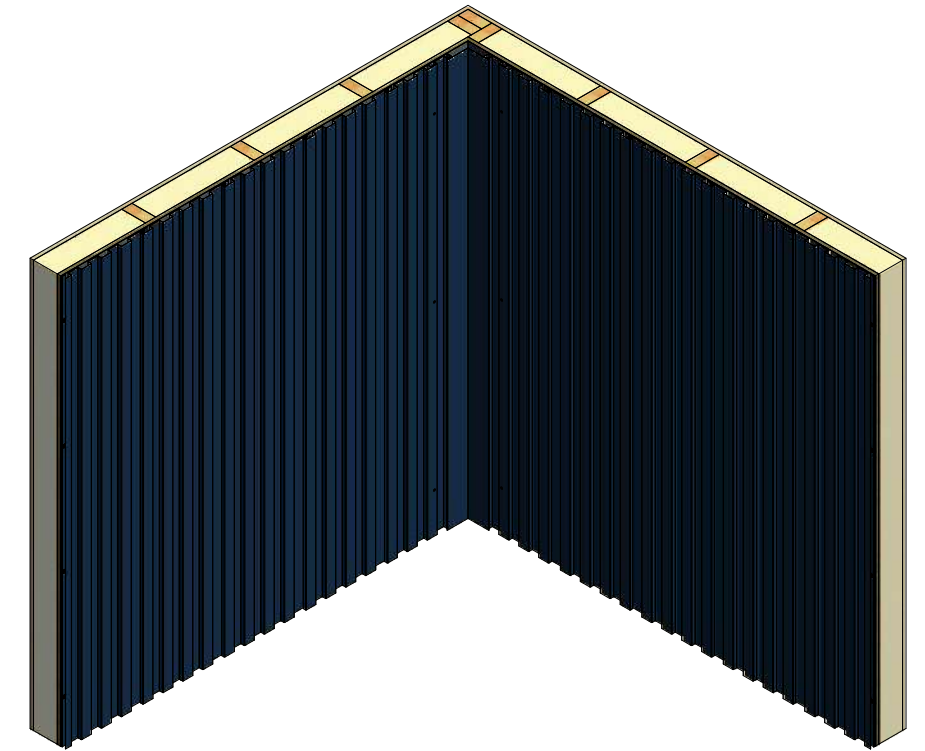
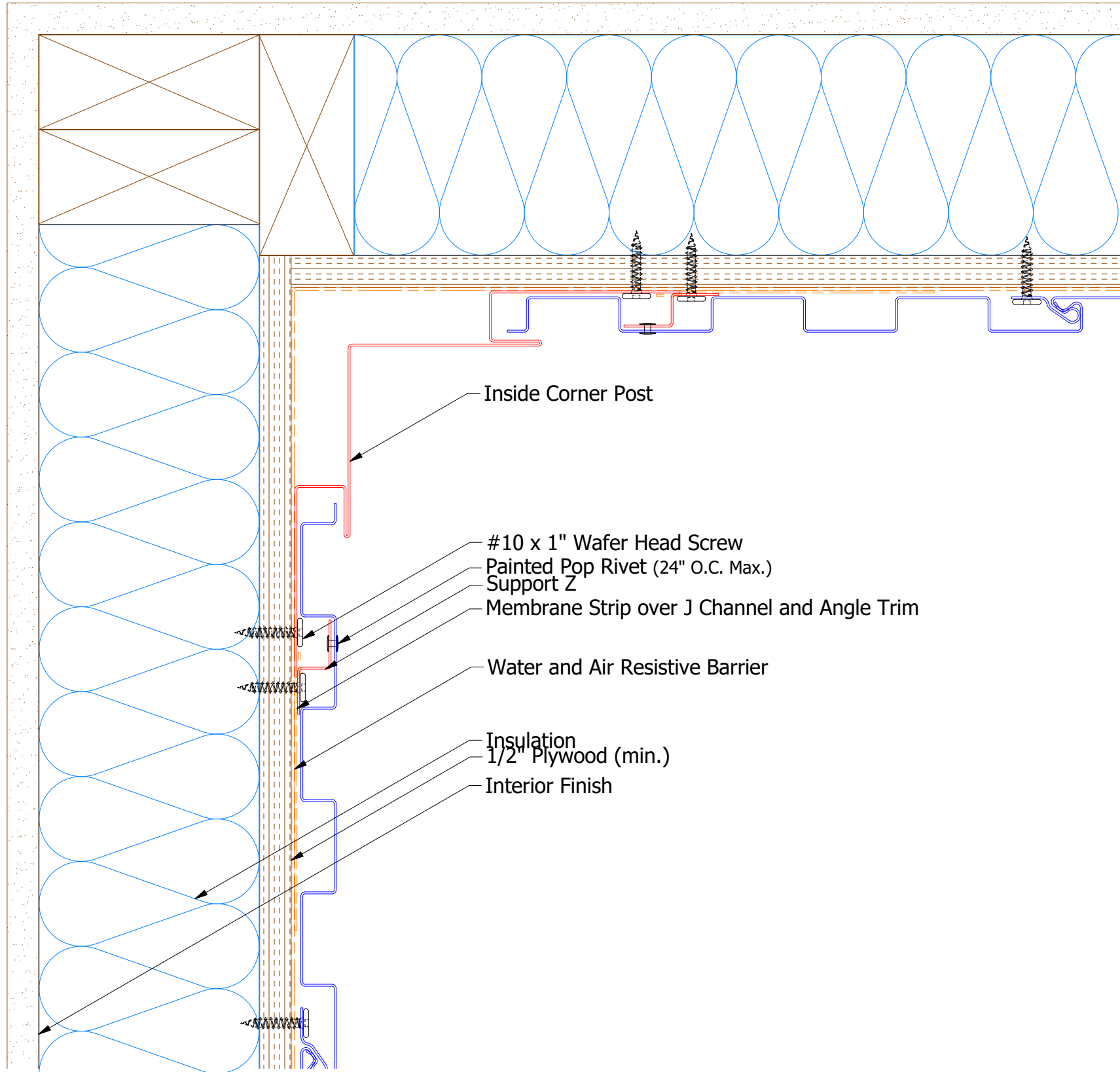

MFA601 - Inside Corner Post

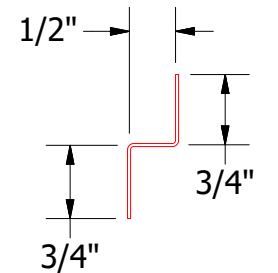

MFA681 - Support Z

Note: * denotes color side.

ATAS INTERNATIONAL, INC
 Allentown PA
 610-395-8445
 Mesa AZ
 480-558-7210

TITLE				Metafor Inside Corner Detail			
DWG. NO.		DR		DATE		DATE	
		MBP		7/8/2016		7/27/16	
MATERIAL		APP		DAS		SCALE	
		SH. SIZE		B		X:X	

REV. NO.	DATE	DESCRIPTION OF REVISION	BY	APP

Vertical Panel

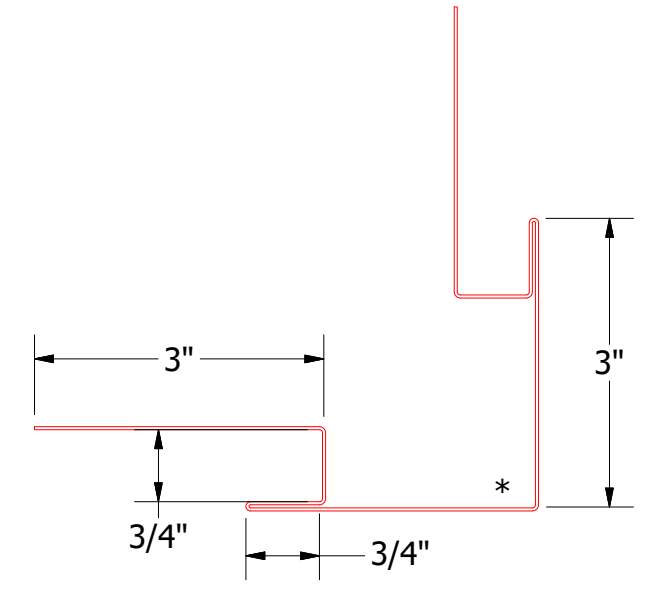
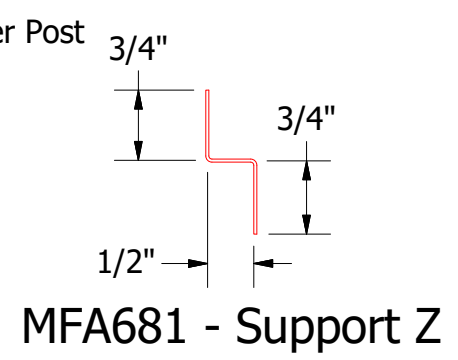
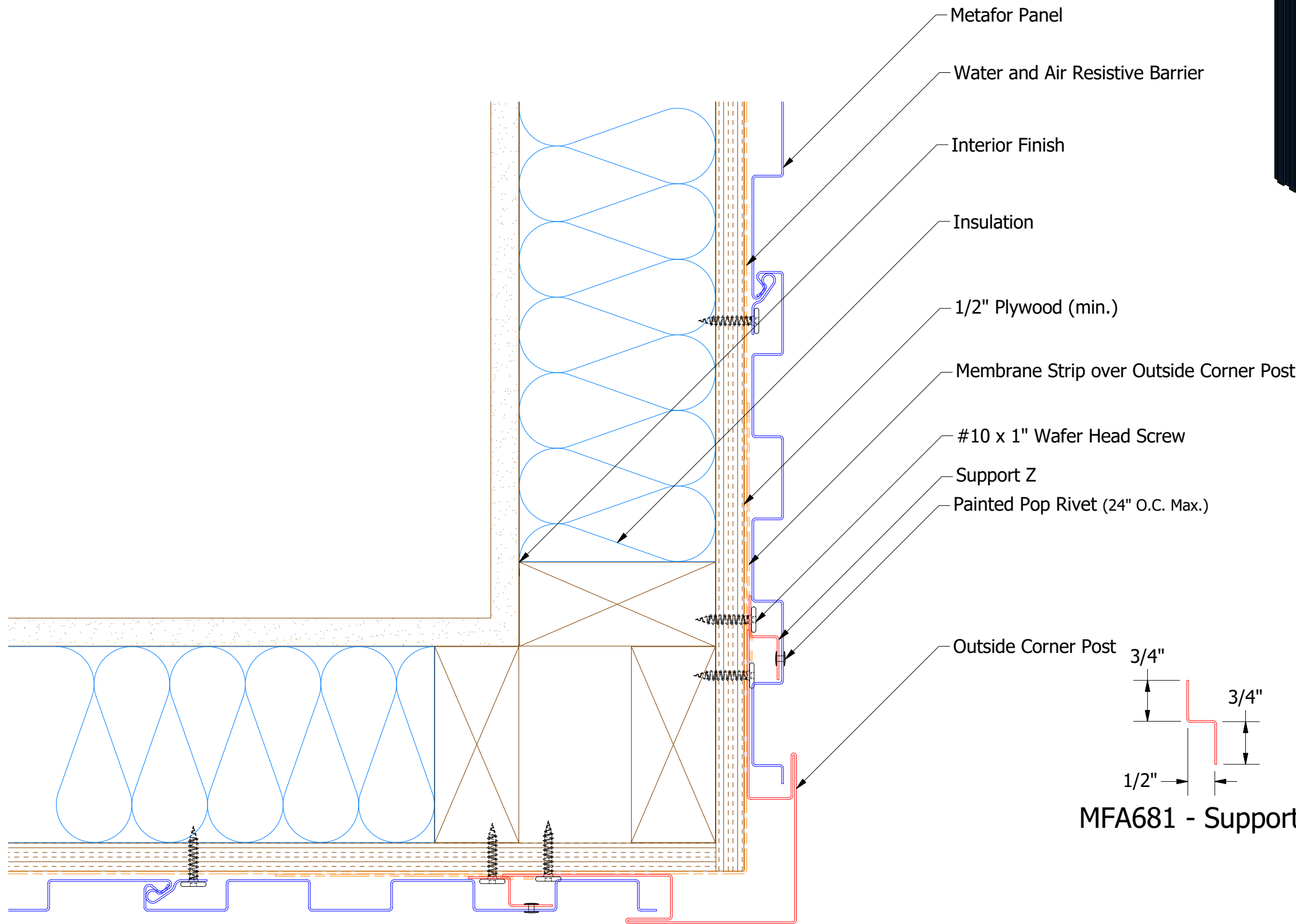
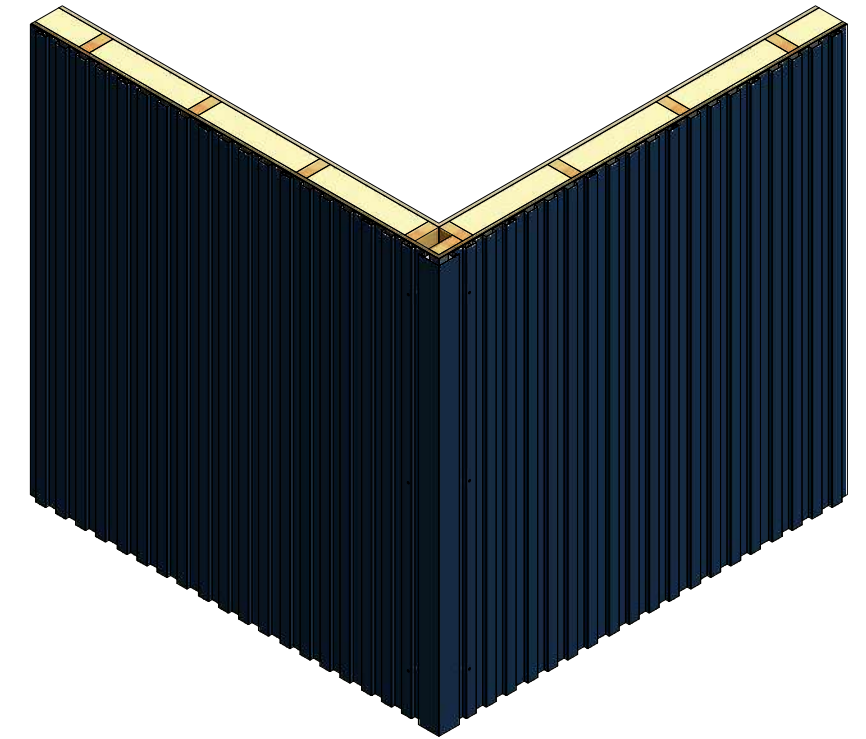

MFA602 - Outside Corner Post

Note: * denotes color side.

ATAS INTERNATIONAL, INC
 Allentown PA
 610-395-8445
 Mesa AZ
 480-558-7210

TITLE				Metafor Outside Corner Detail			
DWG. NO.		DR		DATE		7/8/2016	
APP		MBP		DATE		7/27/16	
MATERIAL		DAS		SH. SIZE		B	
SCALE		X:X					
REV. NO.	DATE	DESCRIPTION OF REVISION	BY	APP			

Vertical Panel

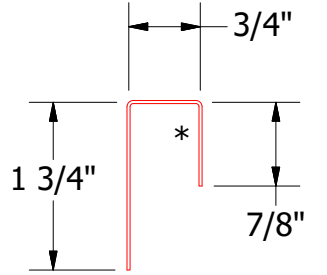
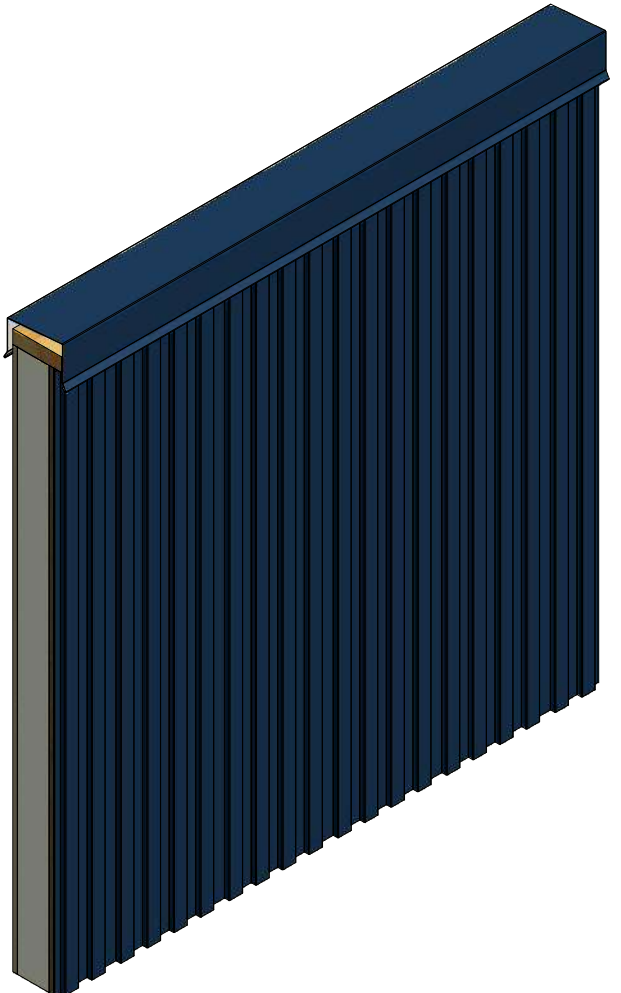
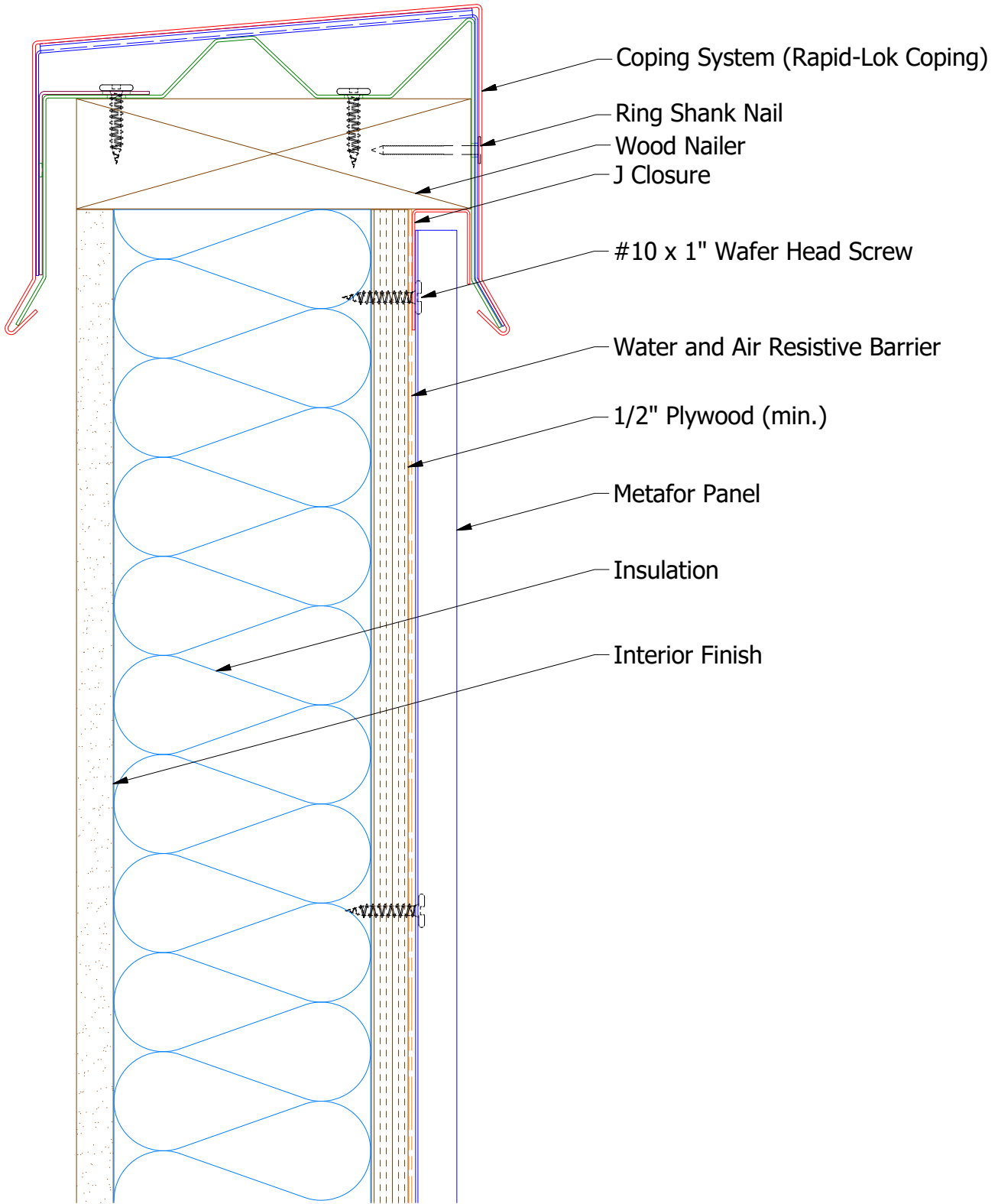

MFA270 - J Closure

ATAS INTERNATIONAL, INC
 Allentown PA
 610-395-8445
 Mesa AZ
 480-558-7210

TITLE		Metafor Top of Wall Detail	
DWG. NO.	DR	DATE	7/8/2016
	DMR	DATE	
MATERIAL	APP	DATE	
REV. NO.	DATE	DESCRIPTION OF REVISION	BY APP
	SH. SIZE	B	SCALE X:X

Note: * denotes color side.

Vertical Panel

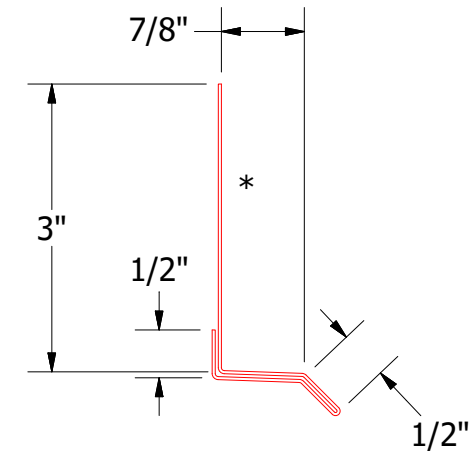
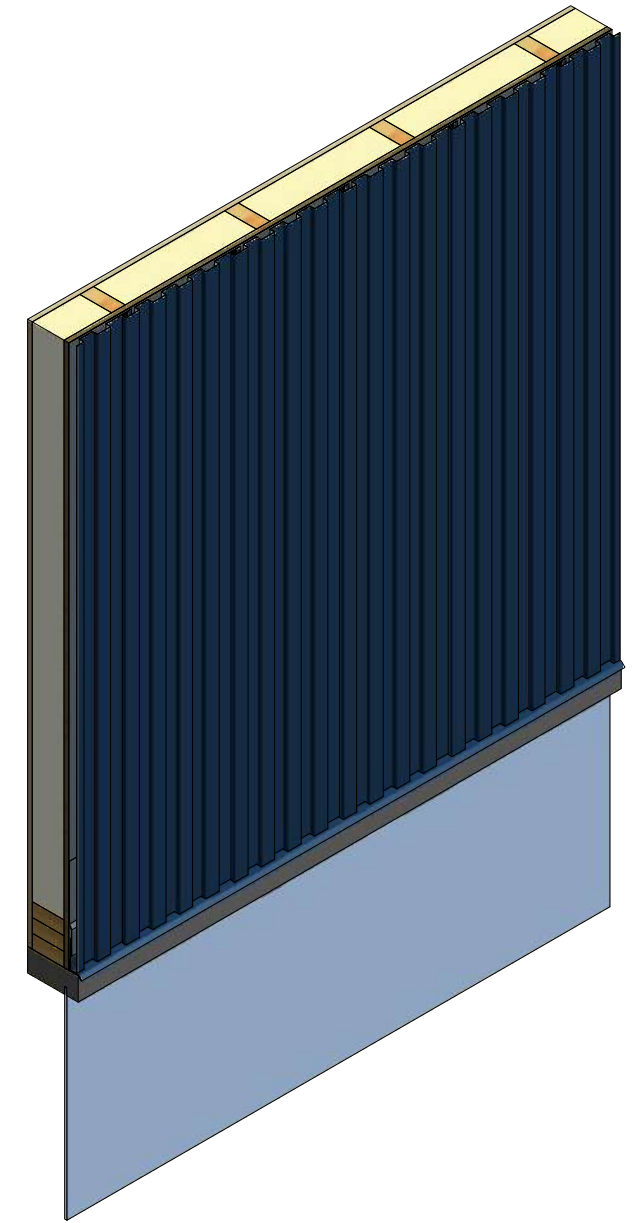
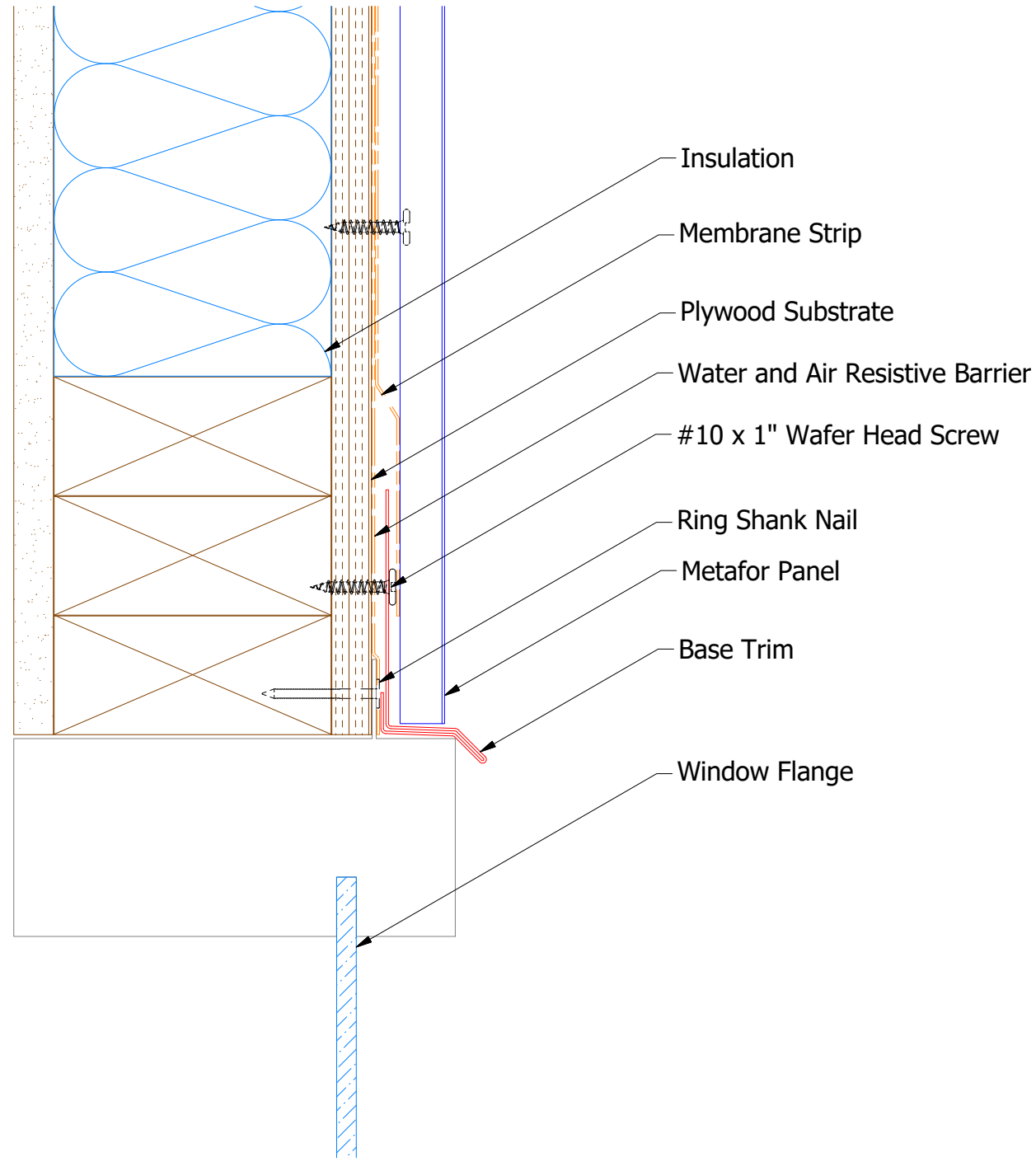

MFA661 - Base Trim



ATAS INTERNATIONAL, INC
 Allentown PA
 610-395-8445
 Mesa AZ
 480-558-7210

TITLE
Metafor Head Window Flange Detail

REV. NO.	DATE	DESCRIPTION OF REVISION	BY	APP	DWG. NO.	DR	DATE
						MBP	8/3/2018
					MATERIAL	APP	DATE
					SH. SIZE	B	SCALE X:X

Note: * denotes color side.

Vertical Panel

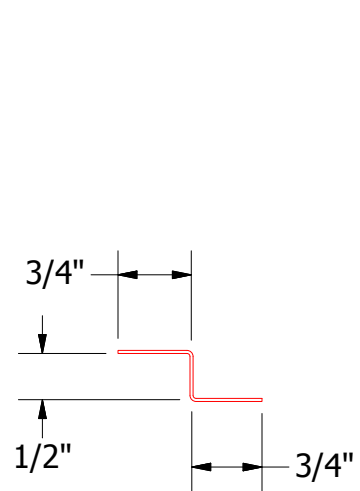
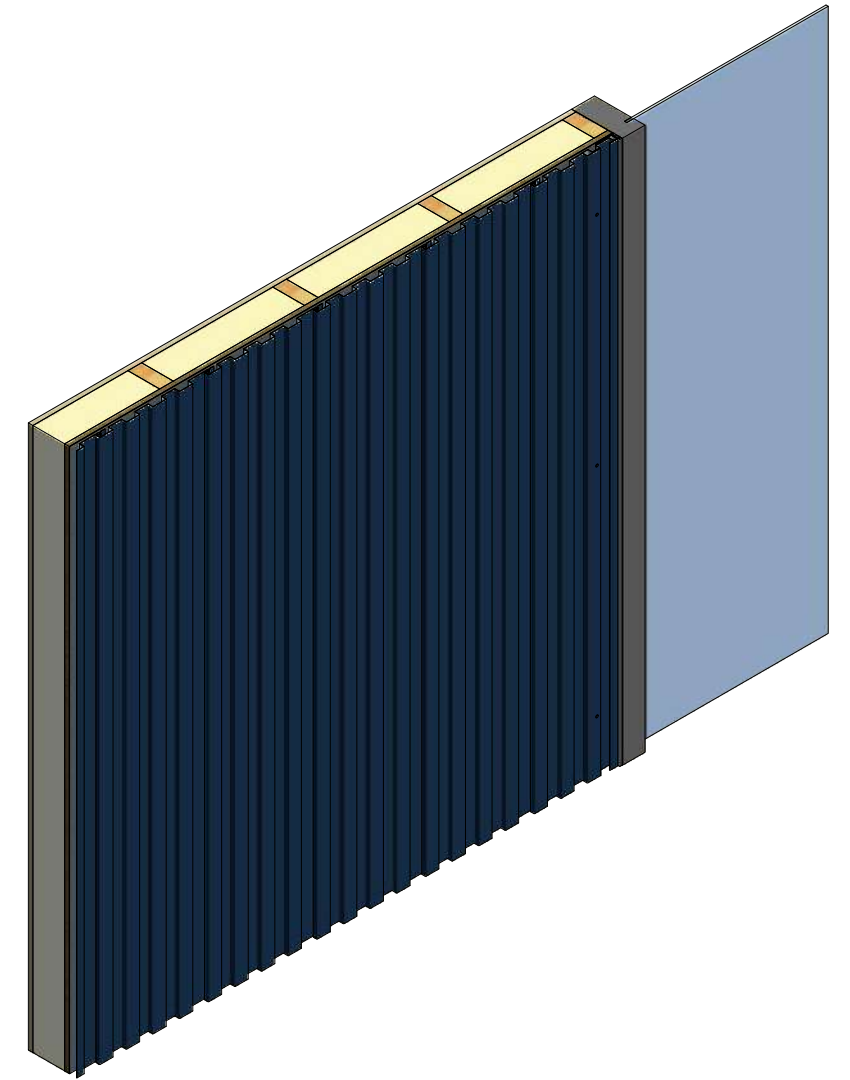
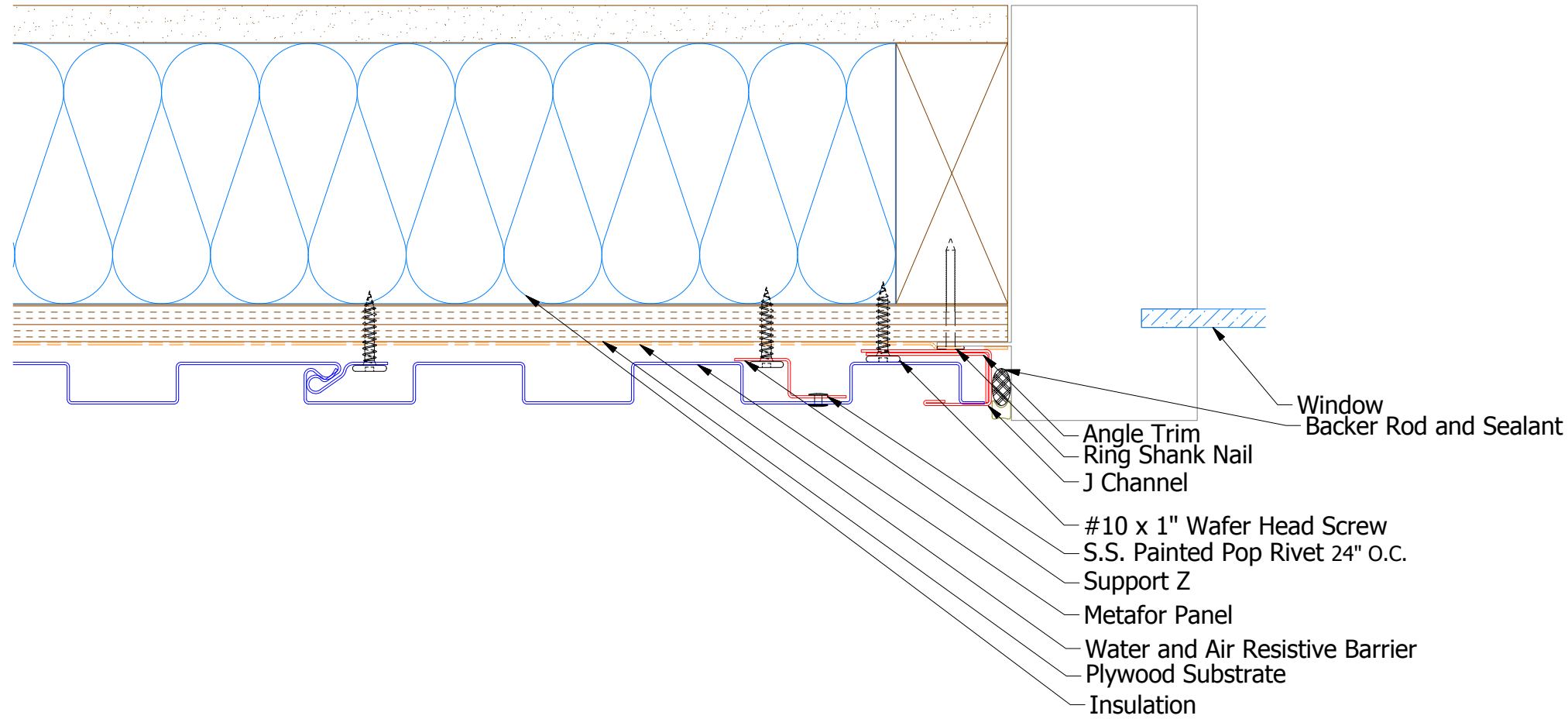

MFA681 - Support Z

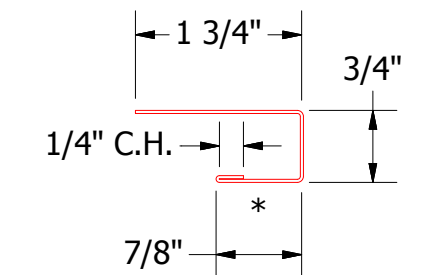

MFA034 - J Channel

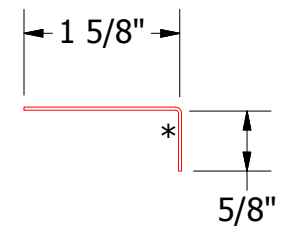

MFA680 - Angle Trim

Note: * denotes color side.

REV. NO.		DATE		DESCRIPTION OF REVISION		BY	APP																		
<table border="1"> <tr> <td colspan="2">DWG. NO.</td> <td>DR</td> <td>MBP</td> <td>DATE</td> <td>8/3/2018</td> </tr> <tr> <td colspan="2">MATERIAL</td> <td>APP</td> <td> </td> <td>DATE</td> <td> </td> </tr> <tr> <td>SH. SIZE</td> <td>B</td> <td>SCALE</td> <td>X:X</td> <td colspan="2"> </td> </tr> </table>								DWG. NO.		DR	MBP	DATE	8/3/2018	MATERIAL		APP		DATE		SH. SIZE	B	SCALE	X:X		
DWG. NO.		DR	MBP	DATE	8/3/2018																				
MATERIAL		APP		DATE																					
SH. SIZE	B	SCALE	X:X																						



ATAS INTERNATIONAL, INC
 Allentown PA
 610-395-8445
 Mesa AZ
 480-558-7210

TITLE
Metafor Jamb Window Flange Detail

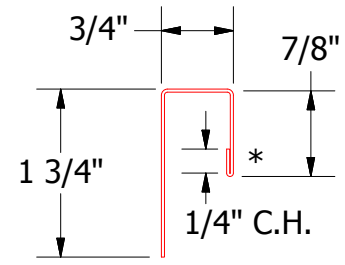
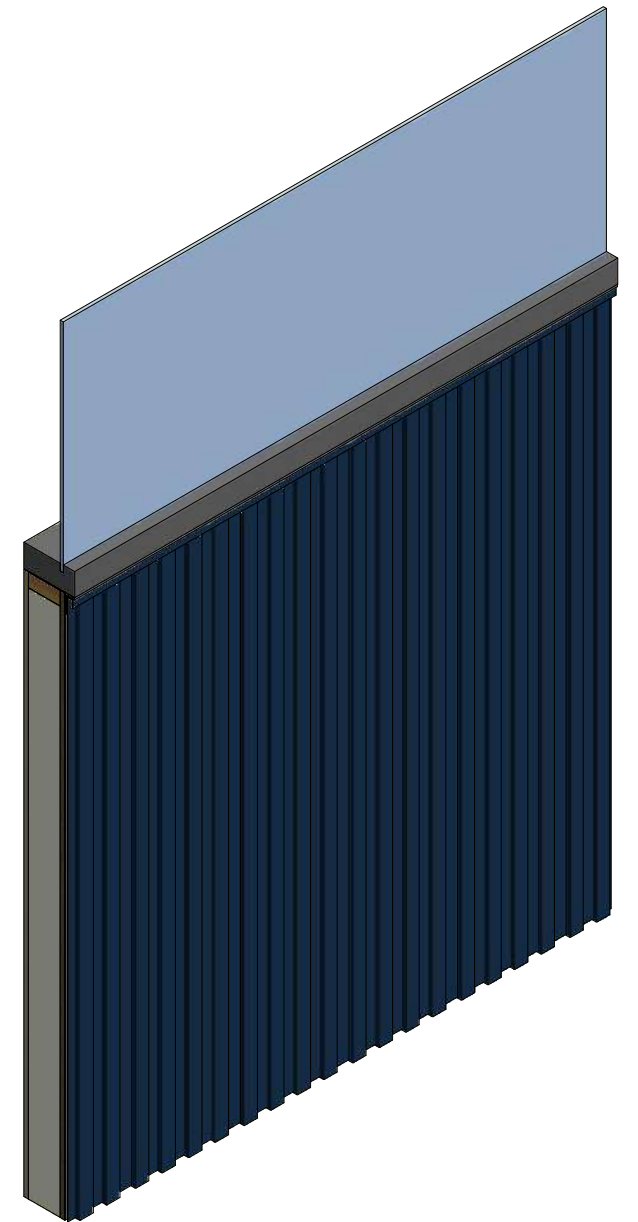
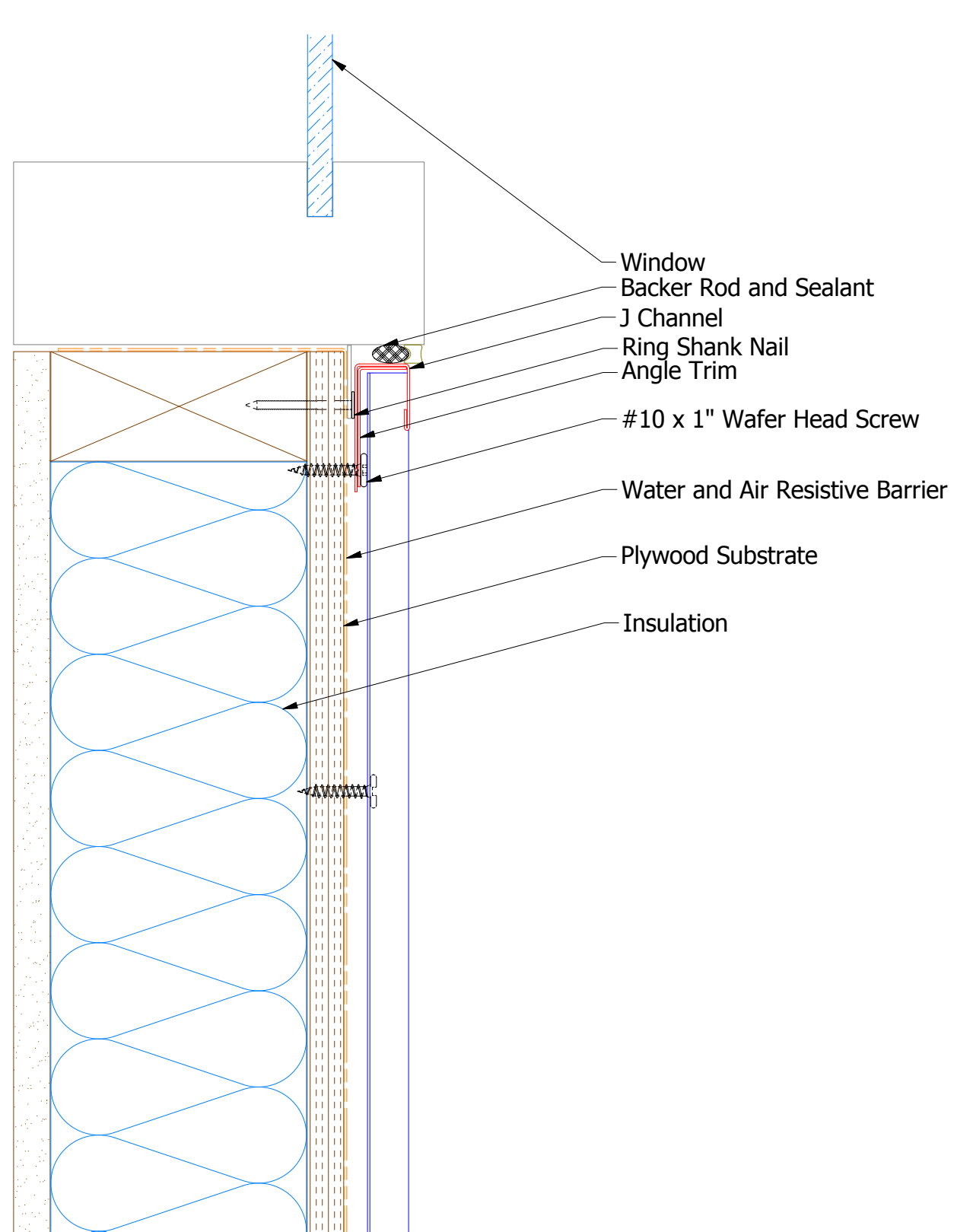
Vertical Panel

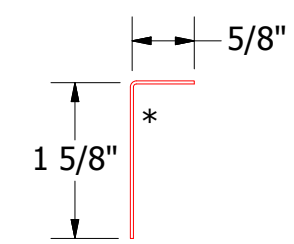

MFA034 - J Channel



MFA680 - Angle Trim

Note: * denotes color side.

ATAS ATAS INTERNATIONAL, INC
 Allentown PA
 610-395-8445
 Mesa AZ
 480-558-7210

TITLE Metafor Window Sill Flange Detail			
DWG. NO.	DR MBP	DATE 8/3/2018	
	APP	DATE	
REV. NO.	DATE	DESCRIPTION OF REVISION	BY APP
	SH. SIZE B	SCALE X:X	

Vertical Panel

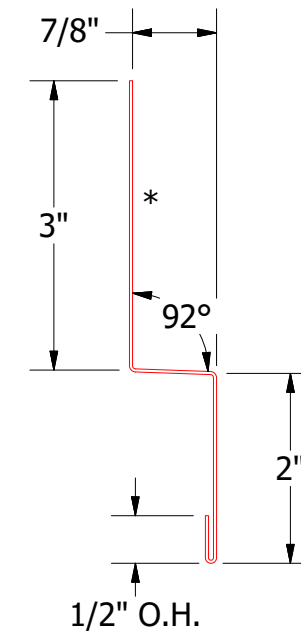
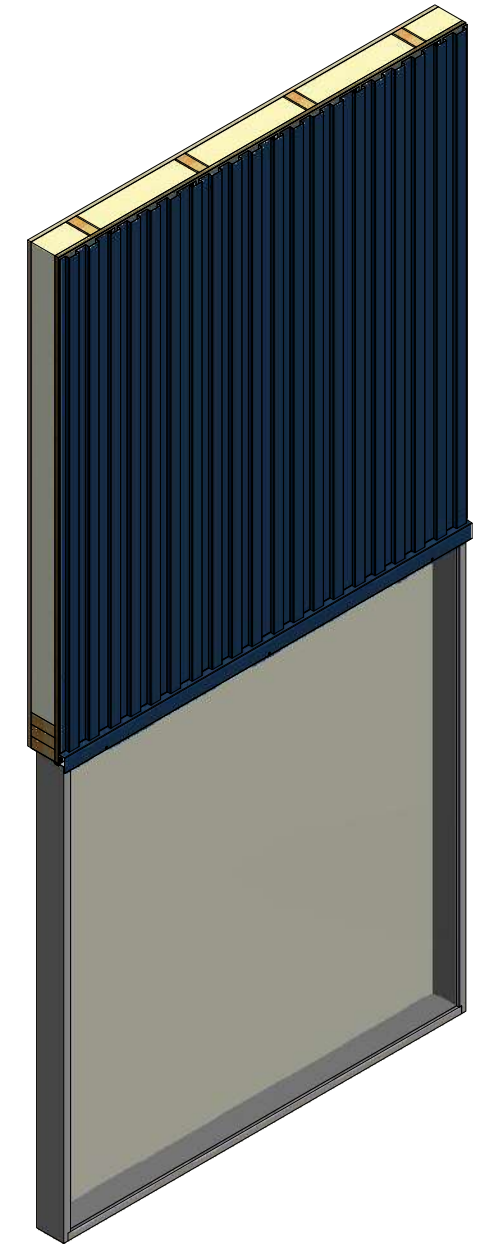
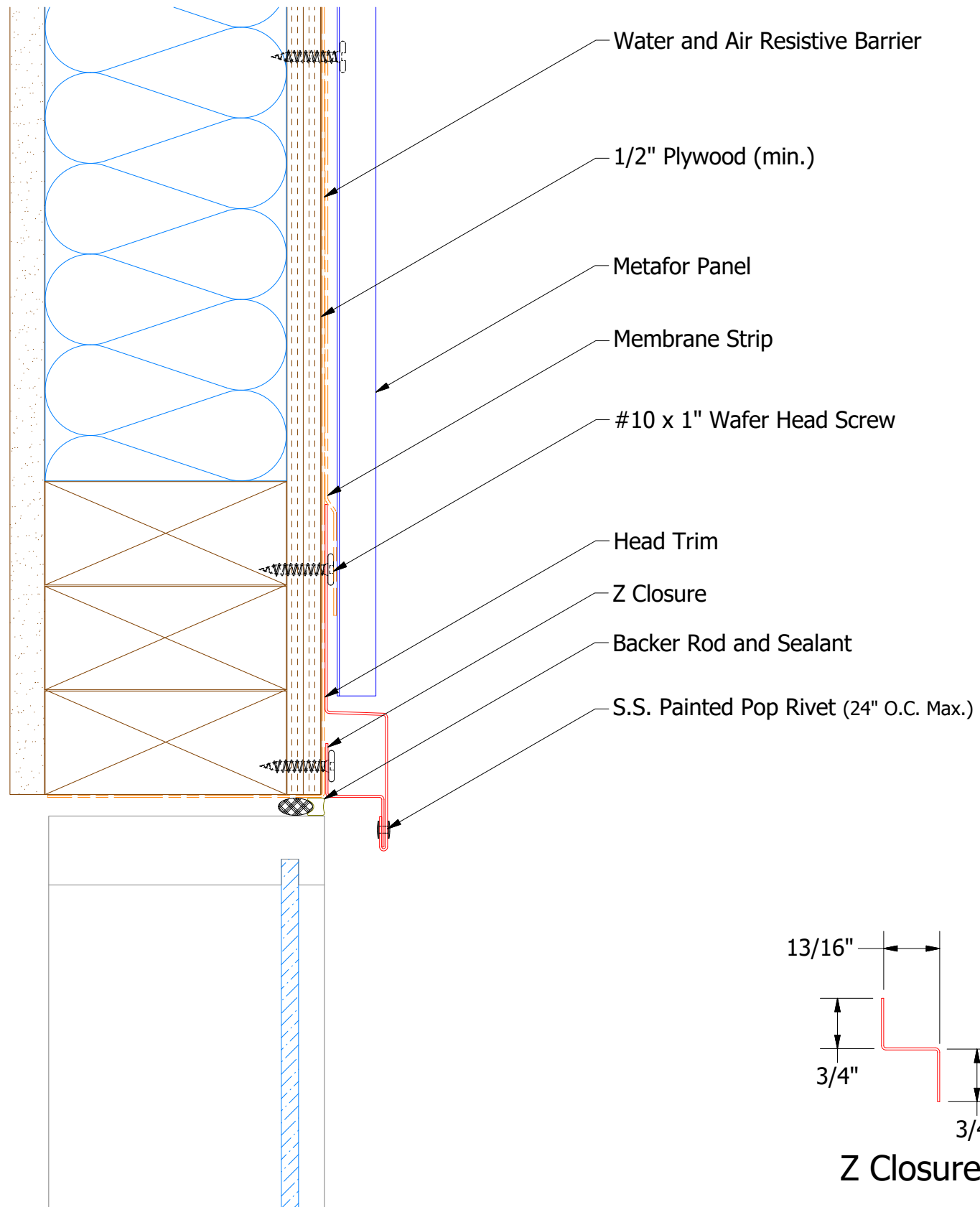

MFA550 - Head Trim

 ATAS INTERNATIONAL, INC Allentown PA 610-395-8445 Mesa AZ 480-558-7210		TITLE Metafor Head Existing Window Detail	
		DWG. NO.	DR MBP
REV. NO.		DATE	DESCRIPTION OF REVISION
BY		APP	
SH. SIZE		B	SCALE X:X

Note: * denotes color side.

Vertical Panel

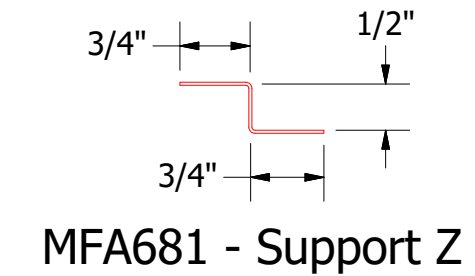
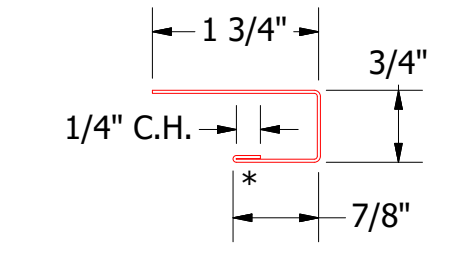
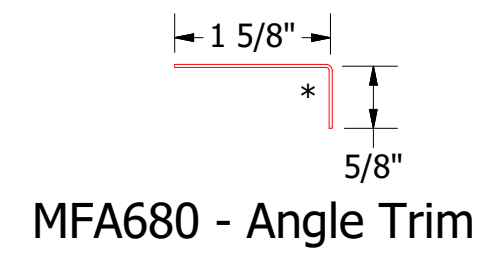
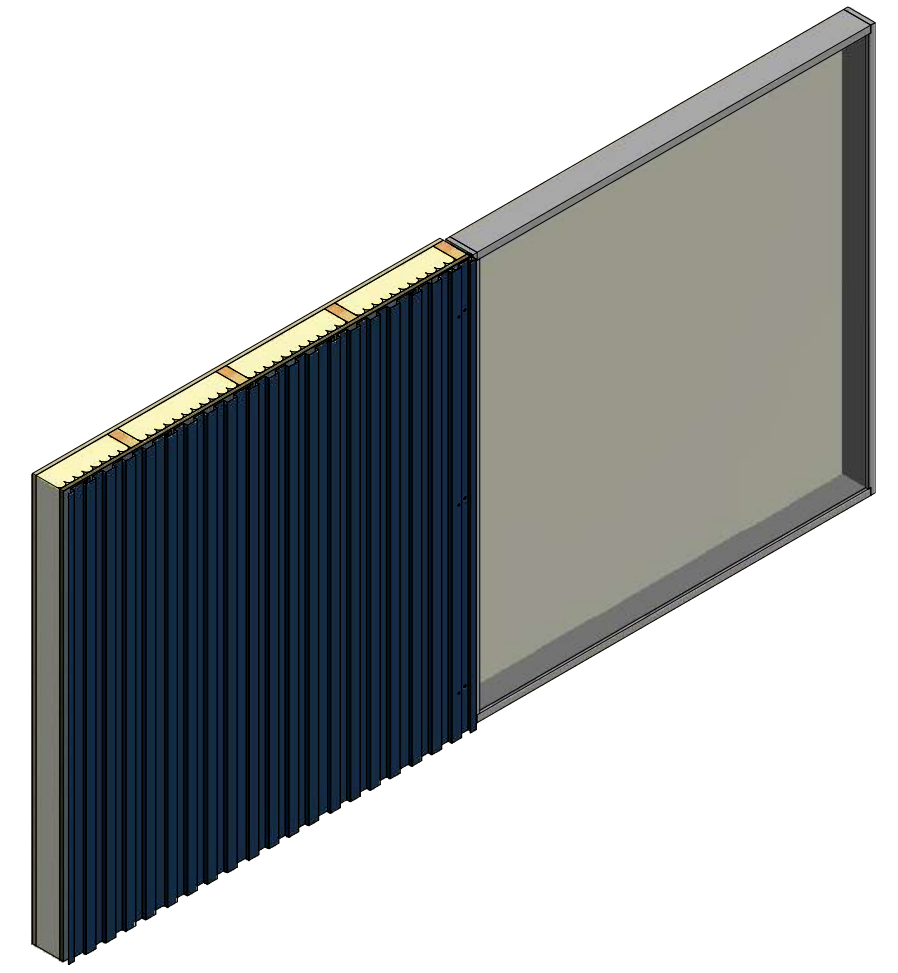
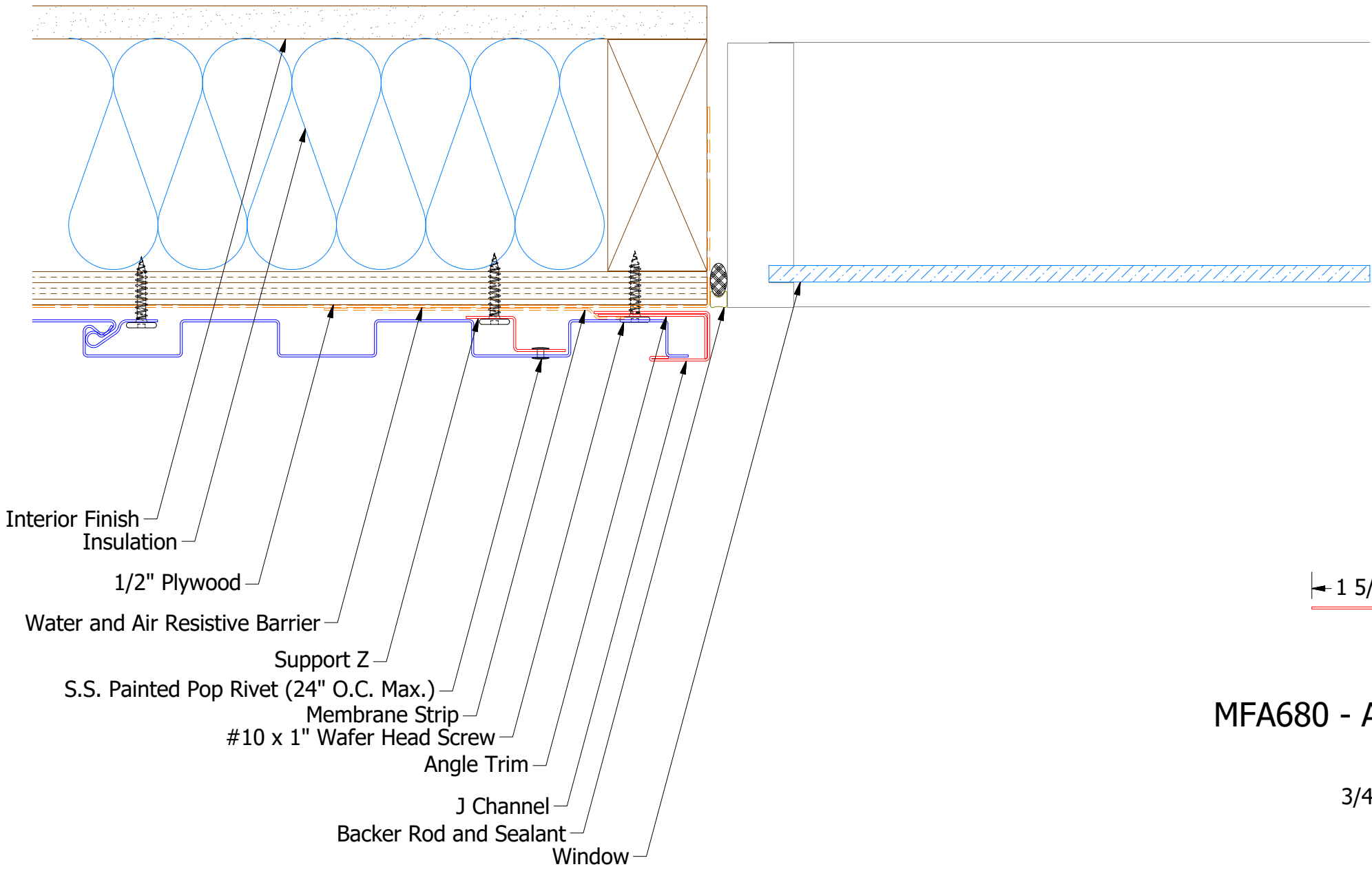

Note: * denotes color side.



ATAS INTERNATIONAL, INC
 Allentown PA
 610-395-8445
 Mesa AZ
 480-558-7210

TITLE				Metafor Jamb Existing Window Detail			
REV. NO.		DATE		DESCRIPTION OF REVISION		BY APP	
DWG. NO.		DR MBP		DATE 7/19/18		APP	
MATERIAL		SH. SIZE B		SCALE X:X			

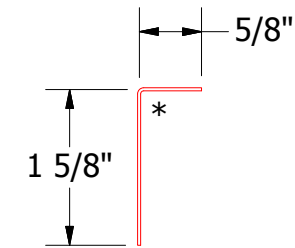
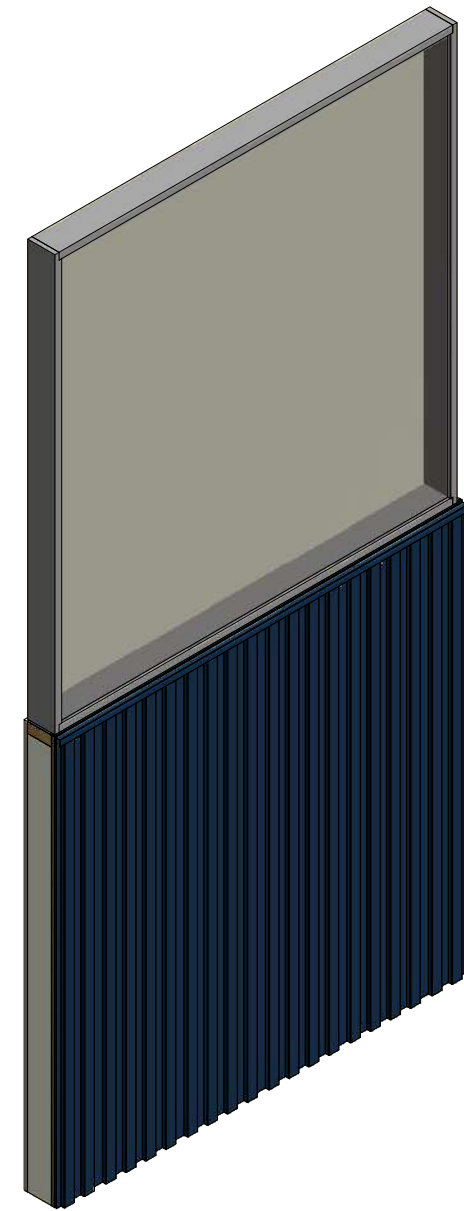
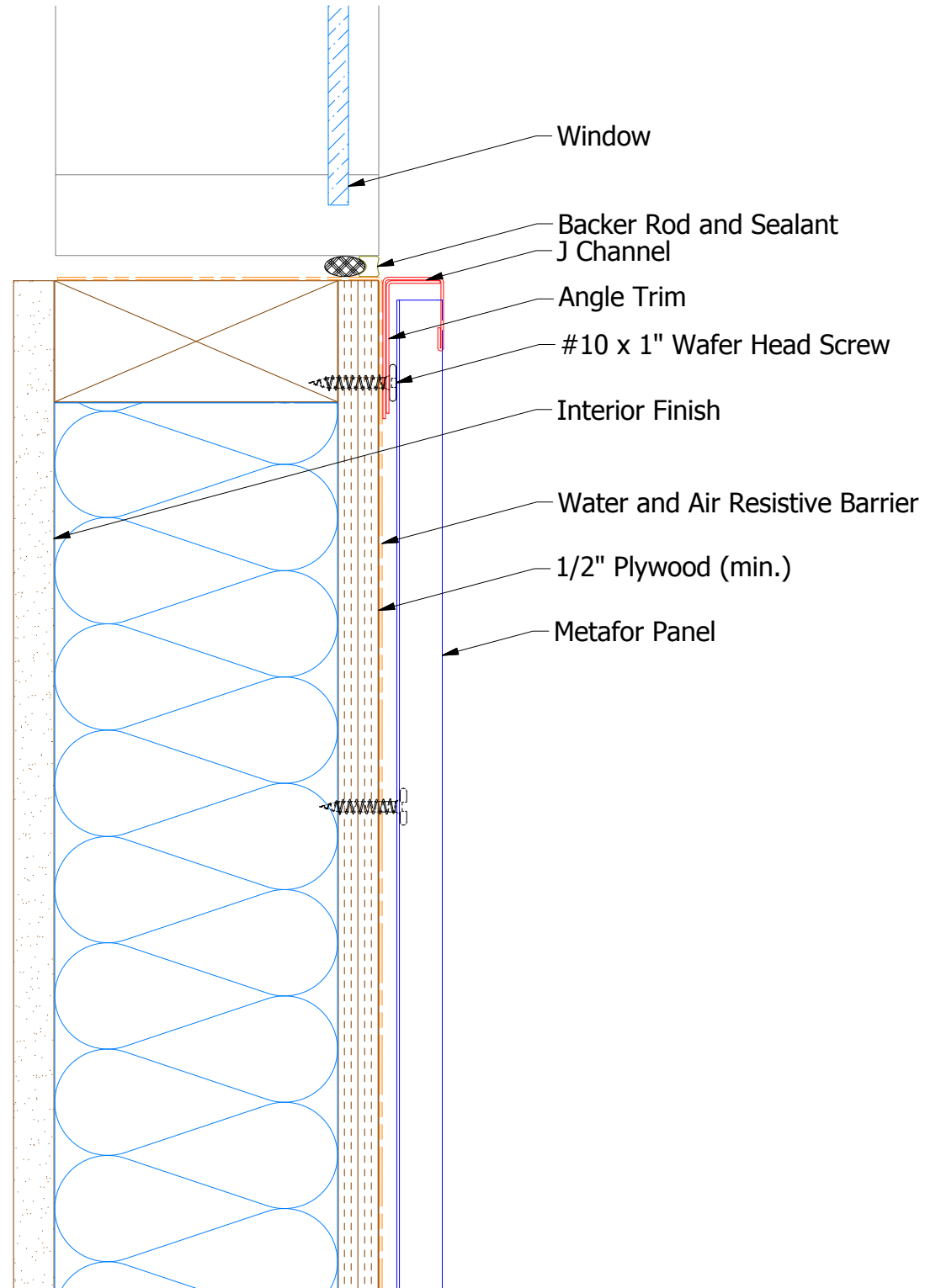
Vertical Panel

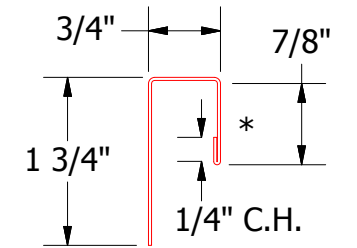

MFA680 - Angle Trim



MFA034 - J Channel

Note: * denotes color side.

 ATAS INTERNATIONAL, INC Allentown PA 610-395-8445 Mesa AZ 480-558-7210		TITLE	
		Metafor Window Sill Existing Window Detail	
DWG. NO.	DR	DATE	7/19/18
	MBP		
MATERIAL	APP	DATE	
REV. NO.	DATE	DESCRIPTION OF REVISION	BY APP
	SH. SIZE	B	SCALE X:X

Vertical Panel

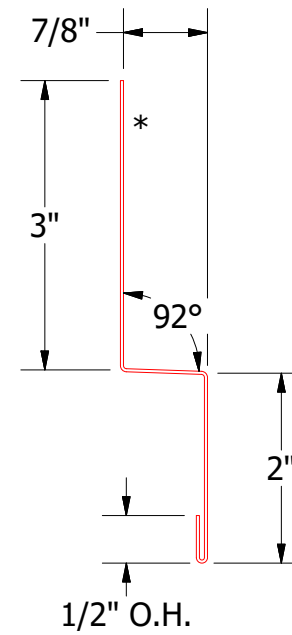
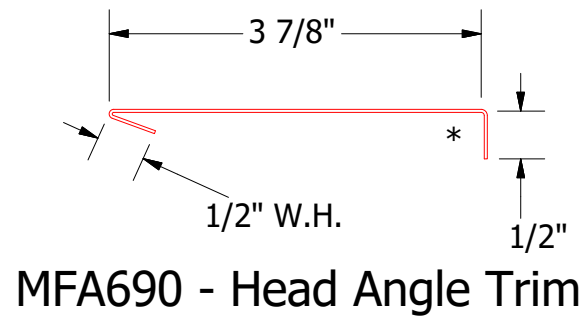
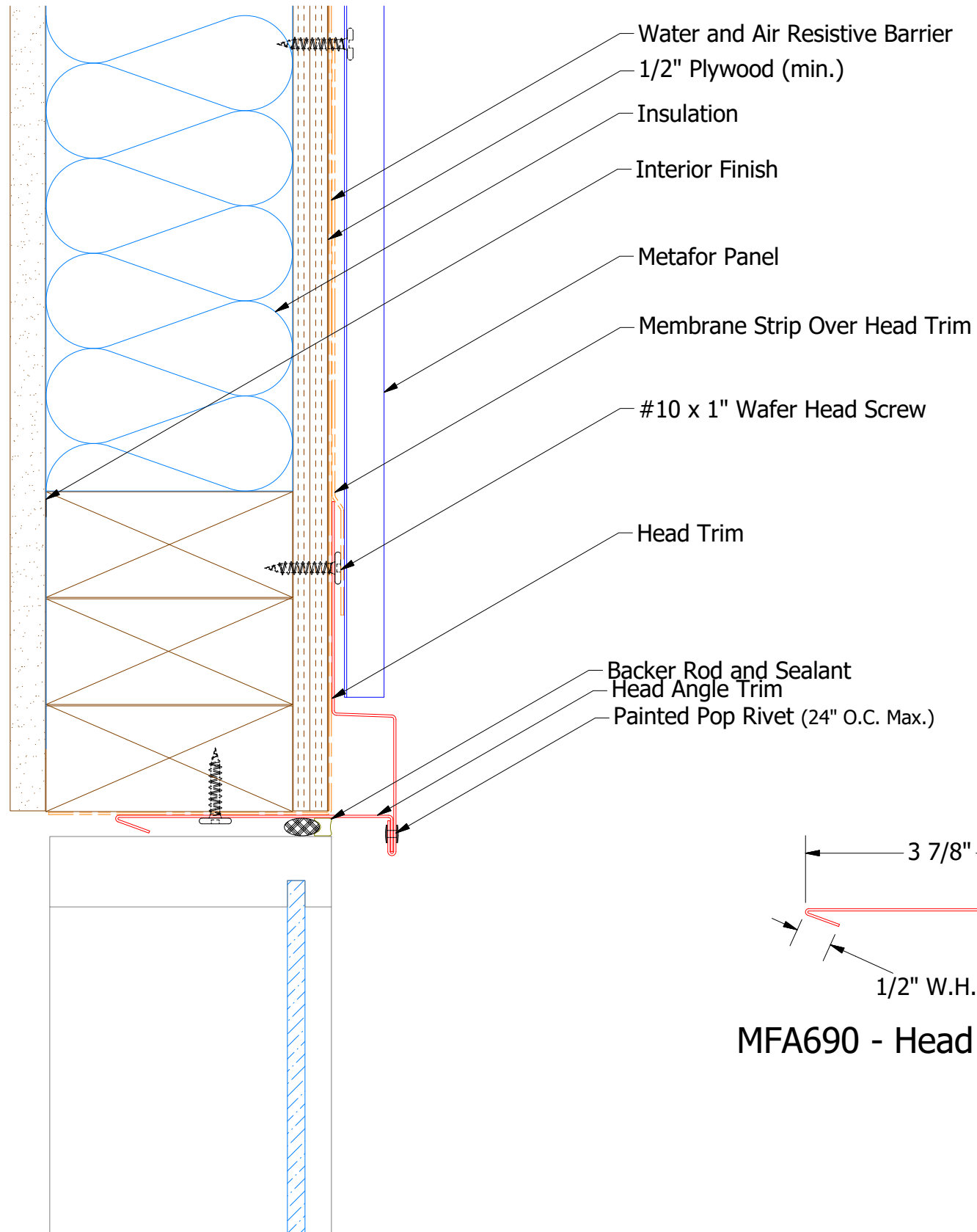

Note: * denotes color side.

ATAS ATAS INTERNATIONAL, INC
 Allentown PA
 610-395-8445
 Mesa AZ
 480-558-7210

TITLE
Metafor Head Detail

REV. NO.	DATE	DESCRIPTION OF REVISION	BY	APP	DWG. NO.	DR	DATE
						MBP	7/7/2016
						DAS	7/27/16
					MATERIAL	SH. SIZE	SCALE
						B	X:X

Vertical Panel

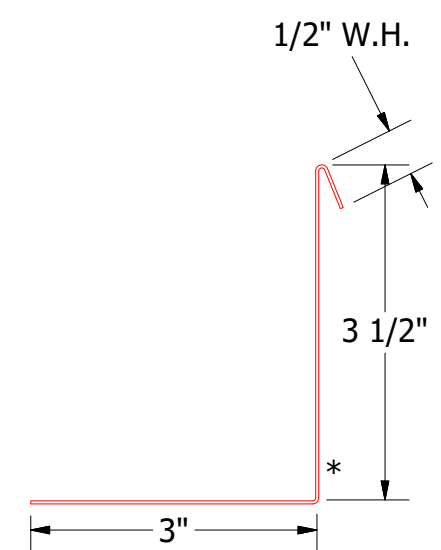
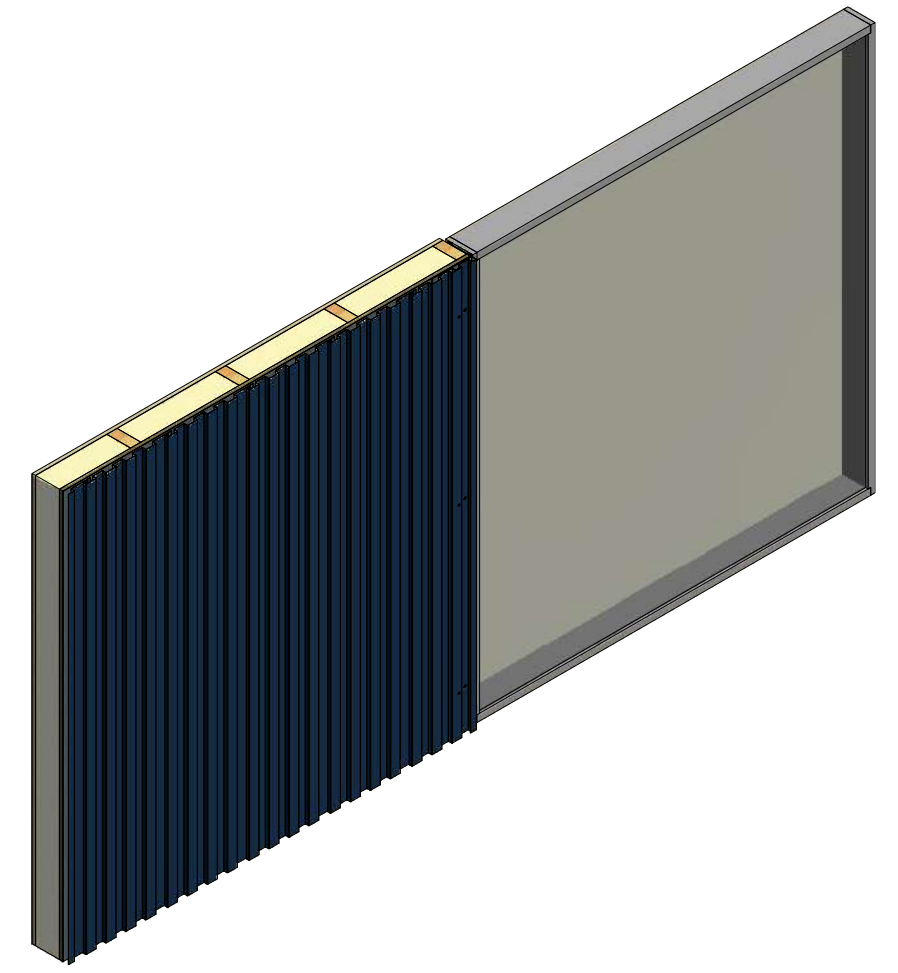
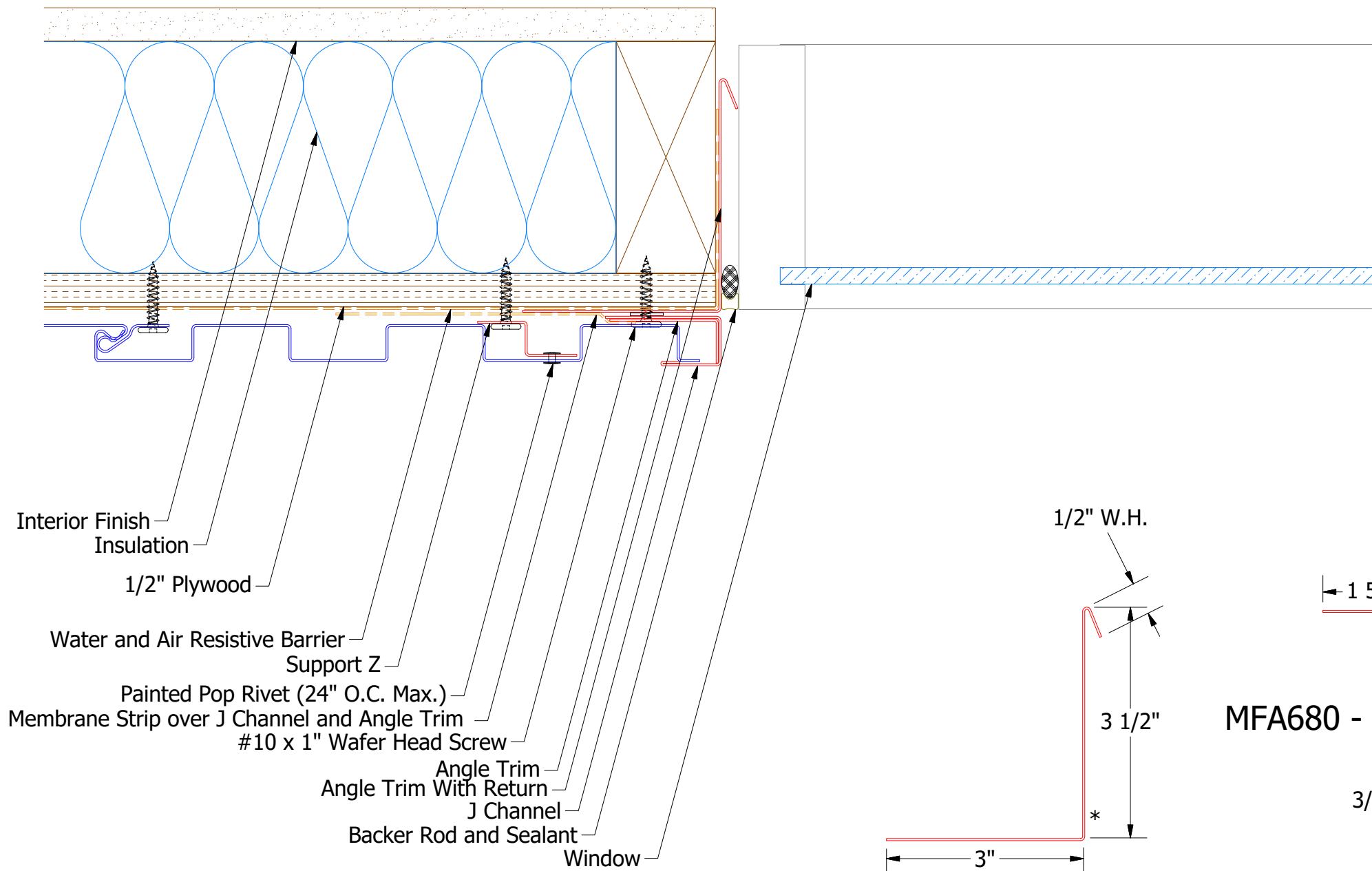

MFA683 - Angle Trim With Return

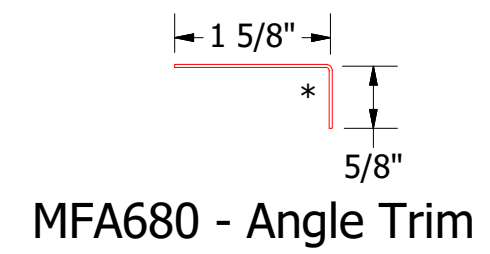

MFA680 - Angle Trim

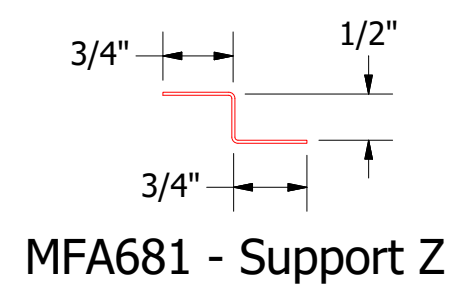

MFA681 - Support Z

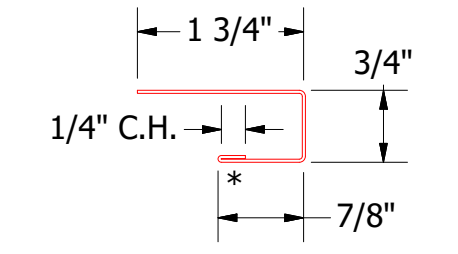

MFA034 - J Channel

Note: * denotes color side.

ATAS ATAS INTERNATIONAL, INC
 Allentown PA
 610-395-8445
 Mesa AZ
 480-558-7210

TITLE		Metafor Jamb Detail		
DWG. NO.	DR	MBP	DATE	7/8/2016
MATERIAL	APP	DAS	DATE	7/27/16
REV. NO.	DATE	DESCRIPTION OF REVISION	BY	APP
			SH. SIZE	B
			SCALE	X:X

Vertical Panel

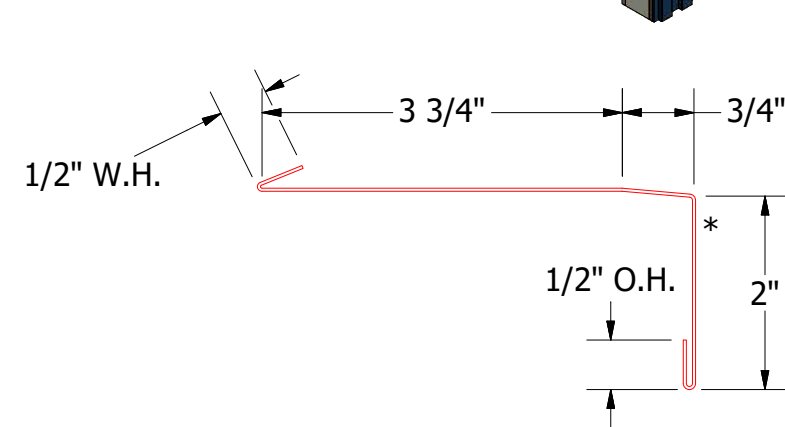
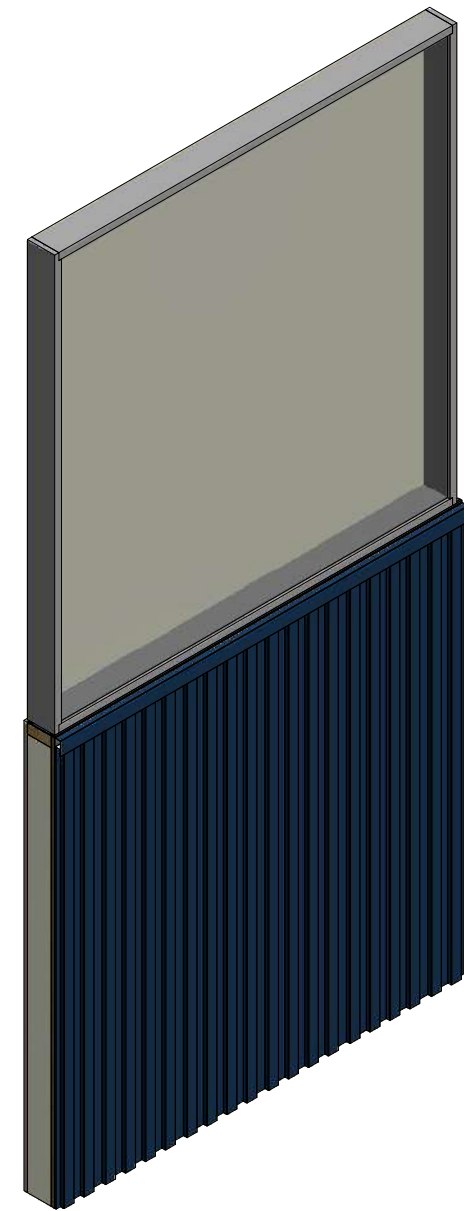
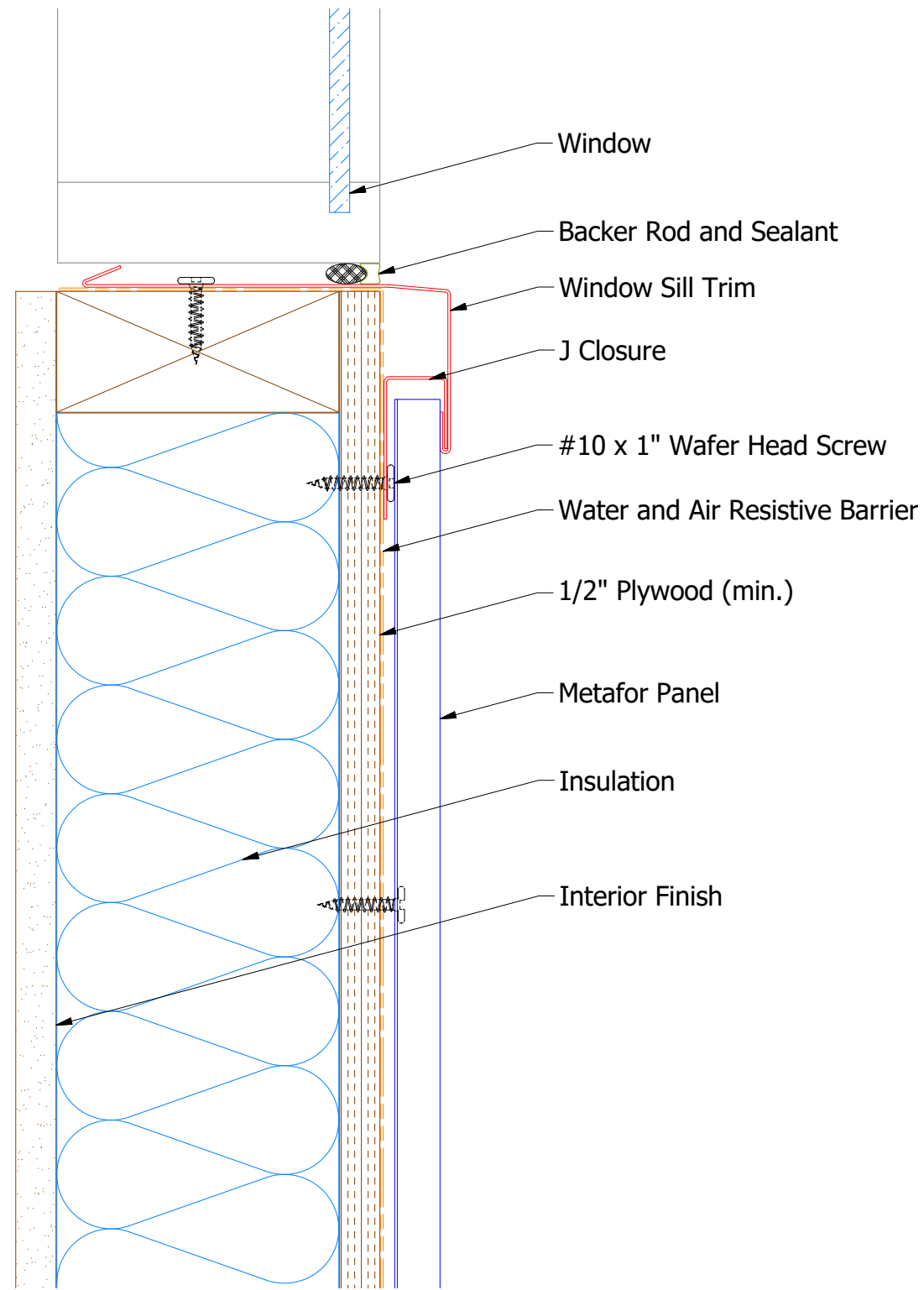

MFA670 - Window Sill Trim

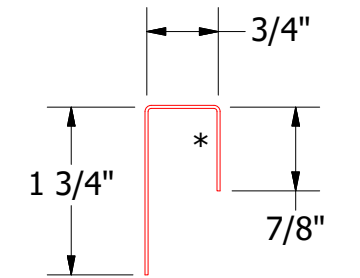

MFA270 - J Closure

Note: * denotes color side.

ATAS ATAS INTERNATIONAL, INC
 Allentown PA
 610-395-8445
 Mesa AZ
 480-558-7210

TITLE				Metafor Window Sill Detail			
DWG. NO.		DR		DATE		7/8/2016	
		DMR					
MATERIAL		APP		DATE		7/27/16	
		DAS					
REV. NO.	DATE	DESCRIPTION OF REVISION	BY	APP	SH. SIZE	SCALE	X:X
					B		